

INSTRUCTION MANUAL

EuroTime Center ETC

Master Clock



Certification of the Producer

STANDARDS

The Euro Time Center ETC was developed and produced in accordance with the EU Guidelines:

2014 / 30 / EU	EMC
2014 / 35 / EU	LVD
2008 / 57 / EU	Railway
2011 / 65 / EU	RoHS
1907 / 2006	REACH



References to the Instruction Manual

1. The information in this Instruction Manual can be changed at any time without notice. The current version is available for download on www.mobatime.com.
2. This Instruction Manual has been composed with the utmost care, in order to explain all details in respect of the operation of the product. Should you, nevertheless, have questions or discover errors in this Manual, please contact us.
3. We are not liable for any direct or indirect damages which could occur when using this Manual.
4. Please read the instructions carefully and only start setting-up the product, after you have correctly understood all the information for the installation and operation.
5. The installation must only be carried out by skilled staff.
6. It is prohibited to reproduce, to store in a computer system or to transfer this publication in a way or another, even part of it. The copyright remains with all the rights with BÜRK MOBATIME GmbH, D-78026 VS-Schwenningen and MOSER-BAER AG – CH 3454 Sumiswald / SWITZERLAND.

Overview

1	Safety	6
2	Maintenance	9
3	General Information: Introduction	10
4	Installation	12
5	Time Administration Concept	13
6	Menu-driven Operation	14
7	Power Supply	16
8	External Time Sources	19
9	Time + Date – Setting and Configuring the Master Clock Time	21
10	Synchronization – Configuration of the External Time Reference	23
11	State – Reception Quality and Alarms	27
12	Slave clock lines	31
13	Serial communication	44
14	Relays	50
15	Switch Program	51
16	Device Supervision	59
17	Data Manager – Configurations and Files	60
18	Miscellaneous	64
19	Maintenance	66
 ANNEX		
A	Connection Diagrams	68
B	Default Configuration	77
C	Time Zone Table	79
D	Alarm List	81
E	Definitions of Protocols	82
F	Connection of GPS 3000 and GPS 4500 Satellite Receiver	88
G	Technical Data	89
G	Index	92
H	Connection Table (to be filled-in)	94

Table of Content

1 Safety	6	10.3 Baudrate Mode (only with CAS synchronisation).....	24
1.1 Safety instructions.....	6	10.4 Baudrate (only with CAS synchronisation) ..	24
1.2 Symbols and Signal Words used in this Instruction Manual.....	6	10.5 Time Zone.....	24
1.3 Intended Use.....	6	10.6 Synchronisation Only.....	24
1.4 Observe operating safety!.....	7	10.7 Alarm Timeout.....	25
1.5 Consider the installation site!.....	7	10.8 System Address (only with CAS synchronisation).....	25
1.6 Please observe the electromagnetic compatibility!.....	7	10.9 State (only with CAN synchronisation) ..	25
1.7 Pay attention to the instructions for the connection of the power supply.....	8	10.10 IP address (only with CAN synchronisation)	25
2 Maintenance	9	10.11 Subnet mask (only with CAN synchronisation).....	25
2.1 Troubleshooting: Repairs.....	9	10.12 Gateway (only with CAN synchronisation) ..	25
2.2 Cleaning.....	9	10.13 NTP server (only with CAN synchronisation).....	26
2.3 Disposing.....	9	10.14 DHCP (only with CAN synchronisation)	26
3 General Information: Introduction	10	11 State – Reception Quality and Alarms ..	27
3.1 Scope of Delivery.....	10	11.1 Reception Quality.....	27
3.2 Technical data.....	10	11.1.1 Telegram Quality.....	27
3.3 Device Designation in this Manual.....	11	11.1.2 Signal Quality.....	27
3.4 Device Description.....	11	11.2 Alarms.....	28
3.5 Device types.....	11	11.2.1 Alarm overview.....	28
4 Installation	12	11.2.2 Alarm Display.....	29
4.1 Connections.....	12	11.2.3 Reset stored alarms.....	29
4.2 Checklist for Start-up.....	12	11.2.4 Alarm masking.....	29
5 Time Administration Concept	13	11.2.5 Alarm contact.....	30
6 Menu-driven Operation	14	12 Slave clock lines	31
6.1 Definitions.....	14	12.1 Line type / Terminals:	31
6.2 Keypad Lock.....	14	12.2 Active Line Current Supervision	32
6.3 Menu Navigation.....	15	12.3 Current Allocation	33
7 Power Supply	16	12.4 Impulse Line.....	34
7.1 Connection Terminals.....	16	12.4.1 Change of the Line State.....	34
7.1.1 Mains Power Supply.....	16	12.4.2 Line Time.....	34
7.1.2 External DC – Power Supply.....	17	12.4.3 Line Date.....	35
7.1.3 Passive Running Reserve Battery.....	17	12.4.4 Line Mode.....	35
7.1.4 Active Running Reserve Battery.....	18	12.4.5 Time Zone.....	35
8 External Time Sources	19	12.4.6 Impulse Length and Impulse Pause	36
8.1 General.....	19	12.4.7 Catch-up Periodicity.....	36
8.2 DCF – Radio Time Receiver.....	19	12.5 DCF Output.....	37
8.3 MSF – Radio Time Receiver.....	19	12.5.1 Change of the Line State.....	37
8.4 GNSS 3000.....	19	12.5.2 Line Time and Date.....	37
8.5 GPS / GNSS 4500.....	19	12.5.3 Time Zone.....	37
8.6 Minute Impulses.....	19	12.5.4 DCF Mode.....	38
8.7 Serial Time Telegram (RS 232 / RS 422).....	20	12.6 Combined DCF-Impulse Output	39
9 Time + Date – Setting and Configuring the Master Clock Time	21	12.6.1 Description.....	39
9.1 Manual Setting of Time and Date.....	21	12.6.2 Change of the Line State.....	40
9.1.1 Time.....	21	12.6.3 Line Time.....	41
9.1.2 Date.....	21	12.6.4 Line Date.....	41
9.2 Time Zone.....	21	12.6.5 Time Zone.....	41
9.3 Quartz Correction.....	21	12.6.6 Line Mode.....	41
9.4 Time Correction.....	21	12.7 MOBALine.....	42
9.5 DCF Time Code Output.....	22	12.7.1 Description.....	42
10 Synchronization – Configuration of the External Time Reference	23	12.7.2 Change of the Line State.....	42
10.1 Time Source.....	23	12.7.3 Line Time and Date.....	42
10.2 Interface.....	23	12.7.4 Line Mode.....	42
		12.7.5 Time Zone.....	43
		12.7.6 Switch Program and World Time Function disable/enable.....	43
		12.7.7 Definition of the World Time Zones	43
		13 Serial communication	44
		13.1 General Description.....	44
		13.2 Parameters / Operating modes.....	46
		13.2.1 Line Time and Date.....	46
		13.2.2 Line Mode.....	46
		13.2.3 Time Zone	47
		13.2.4 Communication Parameters.....	48
		13.2.5 Telegram Format.....	48

13.2.6 Telegram Send Offset	48
13.2.7 Period	49
14 Relays	50
14.1 Switching States	50
14.2 Channel Assignment	50
15 Switch Program	51
15.1 General Description	51
15.2 Simplified channel relay operation	52
15.3 Week Programs	53
15.3.1 Description	53
15.3.2 Insert a New Line Entry	54
15.3.3 Edit a Line Entry	54
15.3.4 Delete a Line Entry	54
15.4 Channel Programs	54
15.4.1 Description	54
15.4.2 Insert a New Line Entry	55
15.4.3 Edit a Line Entry	56
15.4.4 Delete a Line Entry	56
15.5 Channel Monitor	56
15.5.1 Description	56
15.6 Control Inputs	57
15.7 Example of a Switch Program	58
16 Device Supervision	59
17 Data Manager – Configurations and Files	60
17.1 Administration of the Configuration Data	60
17.2 File Download in General	60
17.3 System Software	61
17.4 Switch Program	61
17.4.1 Download Switch Program from a PC	61
17.4.2 Delete Switch Program	61
17.4.3 Read Switch Program from ETC (upload)	62
17.5 Season Table	62
17.5.1 Download Season Table from a PC	62
17.6 Default Configuration	62
17.7 User Configuration	62
17.7.1 Save	63
17.7.2 Restore	63

17.8 Remote Download	63
18 Miscellaneous	64
18.1 Language	64
18.2 Display	64
18.2.1 Contrast	64
18.2.2 Backlight	64
18.3 Versions	64
18.3.1 System Software	64
18.3.2 Core Print PCB	65
18.3.3 Basis Print PCB	65
18.3.4 Season table	65
18.4 Power supply	65
19 Maintenance	66
19.1 Troubleshooting	66
19.2 Reset with Hotkey-Combination	67

ANNEX

A Connection Diagrams	68
B Default Configuration	77
C Time Zone Table	79
D D Alarm List	81
E Definitions of Protocols	82
E.2 NMEA 0183 – Protocol	82
E.3 IF482 – Telegram	83
E.4 DIEM – Telegram	84
E.5 SINEC – Telegram	85
E.6 H7001 – Telegram	86
E.7 BUS485 – Telegram	87
F Connection of GPS 3000 and GPS 4500 Satellite Receiver	88
G Technical Data	89
H Index	92
I Connection Table (to be filled-in)	94

1 Safety



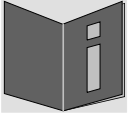

1.1 Safety instructions



Read this chapter and the entire instruction manual carefully and follow all instructions listed. This is your assurance for dependable operations and a long life of the device.

Keep this instruction manual in a safe place to have it handy every time you need it.

1.2 Symbols and Signal Words used in this Instruction Manual

	Danger! Please observe this safety message to avoid electrical shock! There is danger to life!
	Warning! Please observe this safety message to avoid bodily harm and injuries!
	Caution! Please observe this safety message to avoid damages to property and devices!
	Notice! Additional information for the use of the device.
	Important information in the Manual! This information must be followed!

1.3 Intended Use

The **Euro Time Center**, in this manual identified as **ETC**, is a master clock for the use in small to medium clock systems. It can read the time from DCF or GPS (e.g. from GPS 4500).

The ETC can operate as a master clock for a self-setting MOBALine clock line (with switching function for clock lighting, switching program, and world time function) or it can drive a line of impulse clocks. The **ETC 24** has 2 such lines. The ETC 12 can only drive impulse clocks.

For additional functions, see the device descriptions in Chapter 3.4.

ETC xx (wall mounting version):

The wall mounting version of the ETC should be mounted with the enclosed DIN rail or on an existing DIN rail into a closed cabinet. Operate the device only in installed condition. Access to the device only for skilled persons allowed.

ETC xxR (rack version)

The device is designed for 19" racks and intended to be installed in a 19" cabinet. Operate the device only in installed condition.

**Caution!****1.4 Observe operating safety!**

- Never open the housing of the device! This could cause an electric short or even a fire, which would damage your device. Do not modify your device!
- When the device is powered on, it never must be opened or accessed by the hands or any objects through existing openings at the device.
- The device is not intended for use by persons (including children) with limited physical, sensory, or mental capacities or a lack of experience and/or knowledge.
- Keep packaging such as plastic films away from children. There is the risk of suffocation if misused.

**Caution!****1.5 Consider the installation site!**

- To avoid any operating problems, keep the device away from moisture and avoid dust, heat, and direct sunlight. Do not use the device outdoors.
- By operating the device, the heat sinks attached to the sides get warm. Make sure there is enough air circulation for the heat to dissipate. The device shuts off when overheated. After it has regained its normal operating temperature, it will restart automatically. The settings are saved.

**Danger! Make sure**

that you wait before using the device after any transport until the device has reached the ambient air temperature. Great fluctuations in temperature or humidity may lead to moisture within the device caused by condensation, which can cause a short.

**Caution!****1.6 Please observe the electromagnetic compatibility!**

- This device complies with the requirements of the EMC and the Low-voltage Directive.

1.7 Pay attention to the instructions for the connection of the power supply

The connections are described in appendix "A Connection Diagrams".



Danger! Absolutely pay attention:

Mounting, installation, commissioning and repairs of electrical devices must only be carried out by a licensed electrician. While the national installation regulations must be adhered.

For the mains power input a 3 wire mains power cable (2P + PE) with a cross section of at least 0.75 mm² has to be used.

For each power supply connection (**Mains**) / (**DC In**) / (**Bat +**) two fuses of 10A (13A) slow has to be provided (in both lines).

The used fuses for the DC- and battery supply have to be approved for DC.

Each power supply connection (**Mains**) / (**DC In**) / (**Bat +**) needs to be realized with an all-pole disconnection device, which is installed near to the device mentioned in this manual, which is clearly labeled and good accessible.



Before working on a device or on the electrical installations the corresponding circuits have to be switched off and secured against uncontrolled power on.

In case more than one supply voltage is used, including battery power supply, all of them have to be disconnected before starting any maintenance work.

2 Maintenance

2.1 Troubleshooting: Repairs

Please read carefully chapter "19 Maintenance" if your device does not work properly.

If you cannot rectify the problems, contact your supplier from whom you have purchased the device.

Any repairs must be carried out at the manufacturer's plant.

Disconnect the power supply immediately and contact your supplier, if ...

- liquid has entered your device
- the device does not properly work and you cannot rectify this problem yourself.

2.2 Cleaning

- Please make sure that the device remains clean especially in the area of the connections, the control elements, and the display elements.
- Clean your device with a damp cloth only.
- Do not use solvents, caustic, or gaseous cleaning substances.

2.3 Disposing



Device

At the end of its lifecycle, do not dispose of your device in the regular household rubbish. Return your device to your supplier who will dispose of it correctly.



Batteries

The user is legally obliged (**battery regulation**) to return used batteries and accumulators. **Disposing used batteries in the household waste is prohibited!** Batteries/ accumulators containing hazardous substances are marked with the crossed-out bin. The symbol indicates, that this product is forbidden to be disposed in the household waste. Below the chemical shortcuts for the contained hazardous substances of this product are mentioned:



Ag₂O = Silver oxide, **Cd** = Cadmium, **Hg** = Mercury, **Li** = Lithium, **Li-Ion** = Li-ion, **NiCD** = Nickel-cadmium, **NiMH** = Nickel-metal-hybrid, **Pb** = Lead, **ZnMnO₂** = tin-manganese dioxide.

You can return used batteries / accumulators free of charge to any collecting point of your local authority or stores, where batteries / accumulators are sold.

Consequently you comply with your legal obligations and contribute to environmental protection!



Packaging

Your device is packaged to protect it from damages during transport.

Packaging is made of materials that can be disposed of in an environmentally friendly manner and properly recycled.

3 General Information: Introduction

3.1 Scope of Delivery

Please check your delivery for completeness and notify your supplier within 14 days upon receipt of the shipment, if it is incomplete.

The package you received contains:

ETC 12 / 14 / 24 (wall-mounted version)

- Mounting set for wall mounting consisting of:
 - 1 DIN rail
 - 2 screws
 - 2 plastic dowel

All types ETC 12R / 14R / 24R (rack versions)

- Mounting set for rack mounting consisting of:
 - 4 pcs nuts for 19" housing
 - 4 screws M6 for the nuts
 - 4 plastic discs for screws M6
- 2 pcs mounting tools with spring terminals

Only ETC 12R (rack versions)

- Connector set
 - spring terminal 3-pole gray for power supply
 - spring terminal 6-pole orange
 - spring terminal 5-pole orange
 - spring terminal 2-pole orange
 - 2 spring terminal 3-pole orange

Only ETC 14R (rack versions)

- Connector set
 - spring terminal 3-pole gray for power supply
 - spring terminal 10-pole orange
 - spring terminal 5-pole orange
 - spring terminal 2-pole orange
 - 4 spring terminal 3-pole orange

Only ETC 24R (rack versions)

- Connector set
 - spring terminal 3-pole gray for power supply
 - spring terminal 12-pole orange
 - spring terminal 8-pole orange
 - spring terminal 4-pole orange
 - 4 spring terminal 3-pole orange

3.2 Technical data

See Appendix H Technical Data.

3.3 Device Designation in this Manual

This instruction manual is for the master clocks ETC 12, ETC 14, ETC 24 (wall-mounted versions) and ETC 12R, ETC 14R, ETC 24R (rack versions). Below both models will be referred to as **ETC** and only for the special features of the individual models the complete designation is used.

3.4 Device Description

The EuroTime Center ETC operates conventional clock systems with impulse controlled slave clocks as well as modern, self-setting MOBALine installations. Easy and intuitive operation control due to ETC's intelligible user interface. ETC's power relays control light, heating, signalling-bells and other devices by weekly periodic and/or date related programs. Absolute precision of ETC's internal clock can be achieved by synchronisation to an external time-reference such as DCF 77 or GPS.

3.5 Device types

There are three different models of the EuroTime Center ETC available. Each of them is available in a plastic housing for wall mounting or in a 19" wide metal cabinet for rack mounting.

Model:	Main Features:	Product No.:
ETC 12	1 slave clock line (impulse / DCF), 2 switching contacts	201 671
ETC 14	1 slave clock line (impulse / DCF / MOBALine), 4 switching contacts	201 672
ETC 24	2 slave clock lines (impulse / DCF / MOBALine), 4 switching contacts	201 673
ETC 12R	1 slave clock line (impulse / DCF), 2 switching contacts, 19" rack housing	201 674
ETC 14R	1 slave clock line (impulse / DCF / MOBALine), 4 switching contacts, 19" rack housing	201 675
ETC 24R	2 slave clock lines (impulse / DCF / MOBALine), 4 switching contacts, 19" rack housing	201 676

This manual covers all functions of all the different clock types. The exact features of the ETC models are listed in appendix A. If necessary short notes, pictures or examples are added to the manual to explain special options or features of the clock types.

4 Installation

4.1 Connections

The connections of the mains power are specified in chapter 7.
Further connections are specified in Appendix "A Connection Diagrams".
Only connect the designated devices to the various inputs and outputs.

4.2 Checklist for Start-up

The following list should be of assistance for a safe and fast start-up.

- Application specific wiring of the inputs and outputs (Annexe A)
- Connect supply and switch on (Chapter 7, Annexe A)
- Read notes of operation (Chapter 6)
- Set the required menu language (Chapter 18.1)
- Set time zone of the master clock display (Chapter 9.2)
- When available, configure external time reference (Chapter 10.1) and check the reception quality (Chapter 11.1)
- If there is no external time reference, set local time and date manually (Chapter 9.1)
- Configure outputs according to the requirements (Chapter 12)
- Once the configuration of the ETC is completed, save the current settings in the flash memory (Chapter 17.7.1)

5 Time Administration Concept

The internal master clock as well as the battery assisted real-time clock run with UTC (Universal Time Coordinate). The synchronisation inputs and time outputs as well as the time shown on the display are linked via a time zone entry with the master clock time, i.e. all inputs and outputs can be individually allocated to a specific time zone.

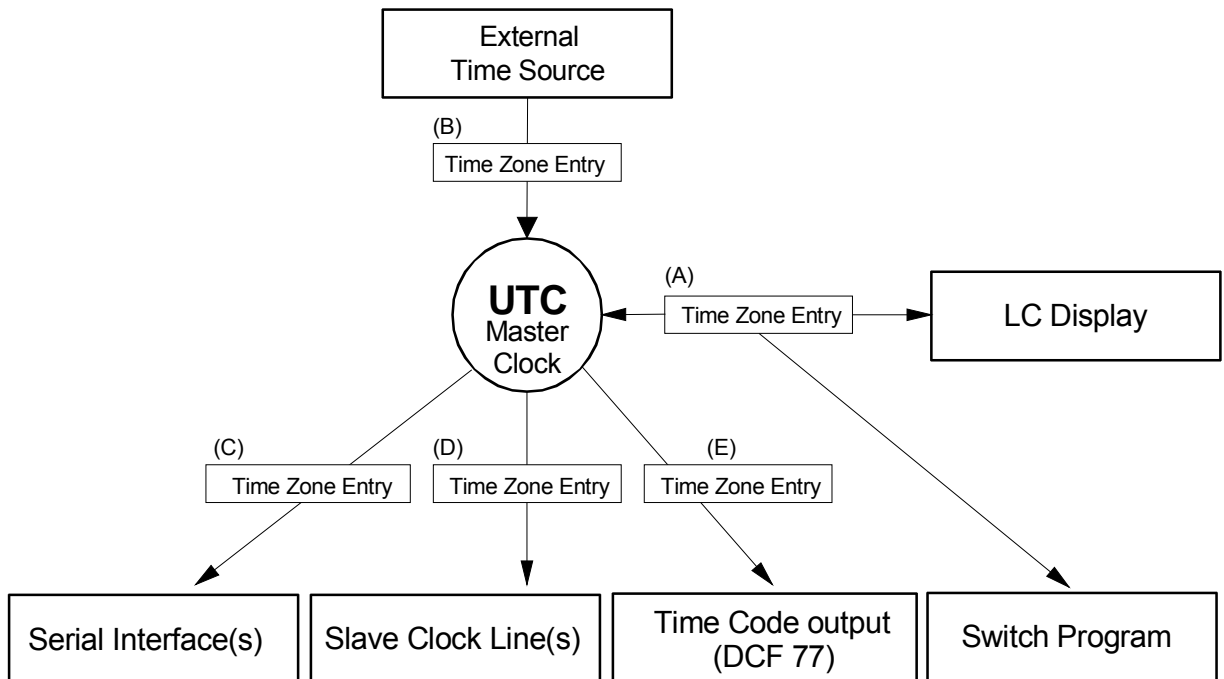

Configurable time zones:

- (A) Chapter 9.2
- (B) Chapter 10.5
- (C) Chapter 13.2.3
- (D) Chapter 12.4.5 / 12.5.3 / 12.7.5
- (E) Chapter 9.5

6 Menu-driven Operation

6.1 Definitions

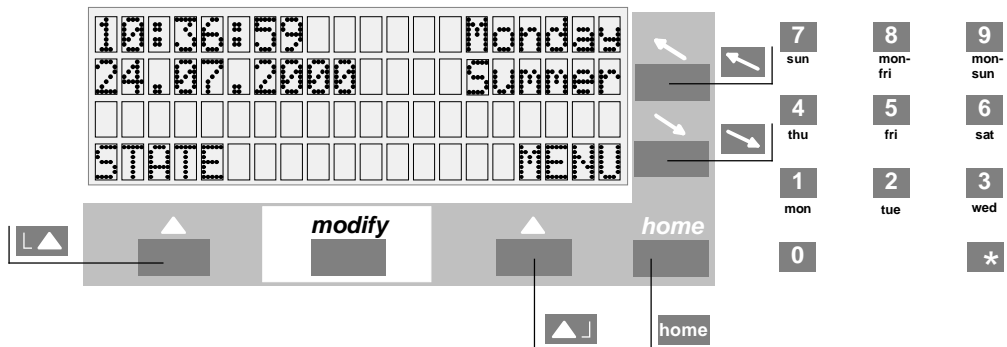

Navigation keys

	Status menu, back
	Main menu, alter, select, OK
	Cursor up/left
	Cursor down/right
	Return to main view

Modify key

	Selecting an entry from a list, indicated by an arrow (↓)
--	---

Numeric keys

6.2 Keypad Lock

Simultaneous actuation of keys **0** + in the main view locks the keypad to prevent further inputs. Simultaneous actuation of the keys **1** + cancels the lock.

The display shows <<<< LOCKED >>>>.

```
10:36:59      Monday
24.07.2000    Summer
<<<<<< LOCKED >>>>>>
```

6.3 Menu Navigation

This example explains how to navigate through the menu of the ETC and how to change a configuration value. The individual menu items are marked by a schematic diagram of the menu tree.

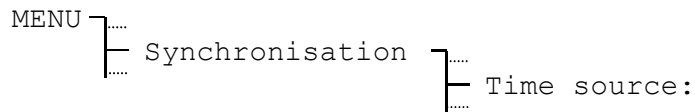

In the following example, the time source is to be set at DCF.

```
10:36:59      Monday
24.07.2000    Summer
STATE                MENU
```

Press the  key (MENU) to enter the main menu.

```
Time + Date
Synchronisation
Slave clock lines
BACK                SELECT
```

The 'Time + Date' line then flashes, using the cursor key  move down by one menu item.



```
Time + Date
Synchronisation
BACK                SELECT
```

The 'Synchronisation' line now flashes, using the navigation key  (SELECT) select this menu item.

```
Time source: none
Configuration
BACK                EDIT
```

The 'Time source' entry now flashes, press the navigation key  (CHANGE).

```
Time source: none
Configuration
CANCEL      ↓      OK
```

Select via the *modify* key , indicated by an arrow above the key. Confirm the selection with the navigation key  (OK).

```
Time source: DCF
Configuration
BACK                EDIT
```

DCF is now configured as the time source. The associated time zone is automatically set at 02 (CET).

Return to the main menu with the  key.

7 Power Supply

7.1 Connection Terminals

There are two ways to feed the ETC. Either you connect the clock to mains power (ETC 14/24: 90 – 240 VAC, ETC 12: 230 VAC +/- 10%, 50/60 Hz) or to an external power supply (24 VDC, 30 VA). See also annexe A.

7.1.1 Mains Power Supply

ETC 12R

Mains power ETC 12R
230 VAC +/- 10%; 50/60 Hz
60 mA / 12 VA max.

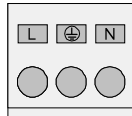

L different colors possible
⊕ yellow-green
N light blue

ETC 12

Mains power ETC 12
230 VAC +/-10%; 50/60 Hz
60 mA / 12 VA max.

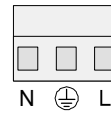

ETC 14R / ETC 24R

Mains power ETC 14R/24R
90 VAC - 240 VAC; 50/60 Hz
0.4 A / 30 VA max.

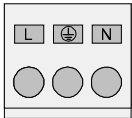

L different colors possible
⊕ yellow-green
N light blue

ETC 14 / ETC 24

Mains power ETC 14/24
90 VAC - 240 VAC; 50/60 Hz
0.4 A / 30 VA max.

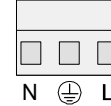

Caution: The ETC was designed for Protection class I. This requires a proper earth connection, if the ETC is mains powered. Otherwise the ETC or the external device could be damaged.

7.1.2 External DC – Power Supply

In case of external power supply from a direct current source it has to be connected to the ETC like shown in the following connection drawing.

ETC 24R

External DC power supply ETC 24R

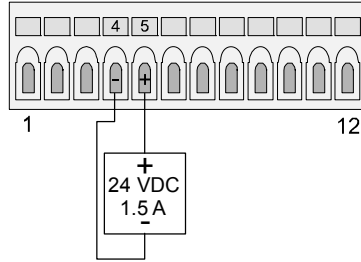

ETC 14R

External DC power supply ETC 14R

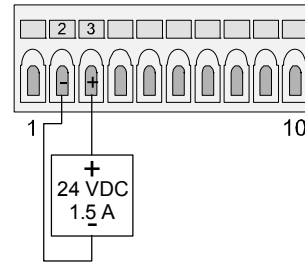

ETC 12R

External DC power supply ETC 12R

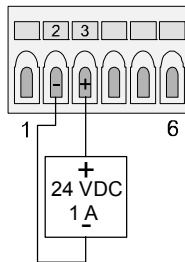

ETC 12/14/24

External DC power supply ETC 12/14/24

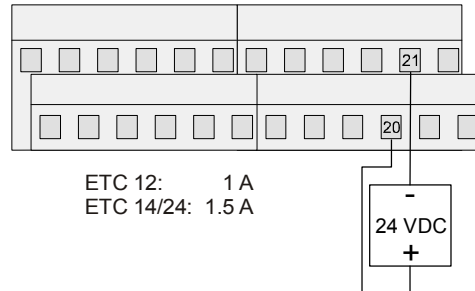

7.1.3 Passive Running Reserve Battery

All ETC-models have a passive running reserve. The fitted lithium battery saves all data and operates the internal RTC (Real Time Clock). After a power failure, the master clock time is again at the precise time. The lithium battery is already fitted and connected upon delivery. Where a master clock has not been in use for over 2 years, the lithium battery should be replaced. When the master clock is connected, the lithium battery has a service life of at least 15 years.

7.1.4 Active Running Reserve Battery

A running reserve battery (type BP ETC R 24 V / 2.3 Ah) can be connected to the ETC to provide all functions during mains power failure. The battery is fully controlled by the ETC which means that it is charged by the ETC and protected against total discharge. The battery is disconnected at approximately 90 % of the nominal voltage. The ETC will then switch to passive running reserve.



Caution: A running reserve battery connected to the ETC will only be activated once the mains supply has been switched on again. This also applies to charged batteries.

ETC 12R

Running reserve battery ETC 12R

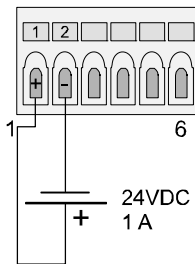

ETC 14R

Running reserve battery ETC 14R

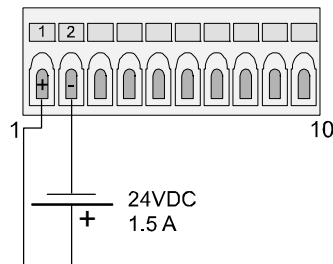

ETC 24R

Running reserve battery ETC 24R

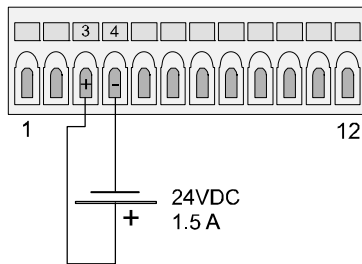

ETC 12/14/24

Running reserve battery ETC 12/14/24

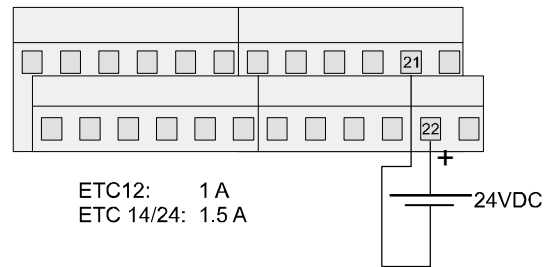

8 External Time Sources

8.1 General

It is possible to connect the ETC to several kinds of time reference. This chapter gives a short description of the time sources. The configuration of the corresponding synchronisation mode will be described in chapter 10.

8.2 DCF – Radio Time Receiver

The connection of a DCF time signal receiver allows the synchronisation from the long wave time signal emitter DCF-77 in Mainflingen (near Frankfurt a.M.), Germany.

The transmission of a time telegram spreads over one minute. After five successive correctly received telegrams the ETC takes over the time information, that means that the synchronisation can last up to 5 minutes at faultless reception.

At good reception the LED in the receiver (DCF 4500) must flash in second rhythm. The signal quality will be increased each second of 1 up to the max. value of 100. For each correctly received time telegram, the value of the telegram quality will be increased of 10 up to the max. value of 100.

Available DCF time signal receivers: DCF 4500

The connection of some time signal receivers is not polarity dependent. For further information please consult the corresponding documentation for the receiver.

8.3 MSF – Radio Time Receiver

The connection of a MSF time signal receiver allows the synchronisation from the long wave time signal emitter MSF-60 in Rugby, England.

Available MSF time signal receivers: MSF 4500

For more information see chapter 8.2.

8.4 GNSS 3000

The GNSS 3000 time signal receiver is sending a DCF time code with UTC time. Time source has to be set to GPS 4500 (time zone 00 [UTC] is predefined, see Chapter 10.1 und 10.5).

The connection diagrams are illustrated in annexe G.

8.5 GPS / GNSS 4500

The GPS / GNSS 4500 time signal receiver is sending a DCF time code with UTC time. Time source has to be set to GPS 4500 (time zone 00 [UTC] is predefined, see Chapter 10.1).

The connection diagrams are illustrated in annexe G.

8.6 Minute Impulses

The opto-coupler interface (Art. No. 118922) allows the synchronisation with polarised minute impulses of 24 V or 48 V. The setting of date and time must be made manually. The seasonal time change-over will be executed automatically.

The opto-coupler interface has to be connected to the terminals DCF in +/-, see also annexe A.

8.7 Serial Time Telegram (RS 232 / RS 422)

The IF 482 telegram is a serial ASCII standard time telegram, which sends the time and date information through the serial interface RS 232 or RS 422. The detailed specification can be found in annexe F.

9 Time + Date – Setting and Configuring the Master Clock Time

9.1 Manual Setting of Time and Date

Manual setting of the time is required where no external time reference is connected or the clock is set to 'synchronisation only'. Automatically read-in of time information from external time sources overwrites the manual input.

When operating without a time source, set the time zone prior to setting the time, see Chapter 9.2.

9.1.1 Time

Manual setting of the time for the master clock unit without modification of the date. The shown time corresponds to the selected time zone, see Chapter 9.2.

```
MENU }  
    }  
    } Time + Date }  
    }  
    } Time: 15:13:09
```

9.1.2 Date



Manual setting of the date for the master clock unit without modification of the time.

```
MENU }  
    }  
    } Time + Date }  
    }  
    } Date: 04.07.04
```

9.2 Time Zone

Choice of time zone. This entry determines the time for the main display and the treatment of the switch program. See also time zone entry (A) in graphic of Chapter 5.

```
MENU }  
    }  
    } Time + Date }  
    }  
    } Time zone:
```

The cursor keys  /  are used for selection from the 100 possible entries, or the time zone can be selected by means of a numerical input.

9.3 Quartz Correction

Manual correction of the quartz drift.

```
MENU }  
    }  
    } Time + Date }  
    }  
    } Quartz correction
```

The quartz drift is corrected through input of the observed weekly time deviation between -60.0 to +60.0 seconds. This function is not important when operating with an external time reference.

9.4 Time Correction

Time correction of the master clock time between -60.0 to +60.0 seconds.

```
MENU }  
    }  
    } Time + Date }  
    }  
    } Time correction
```

9.5 DCF Time Code Output

Configuration of the synthetic DCF time code output.

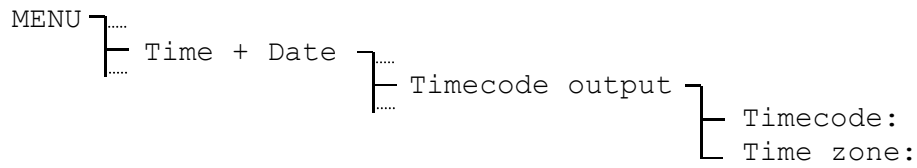

Timecode output: **None, DCF**
 Time zone: **00 to 99**, standard is 02 = CET (Central Europe Time)

The DCF time code output is synthetic and thus independent of the selected synchronisation mode and the time signal reception. The signal is DC coded and galvanic separated over a passive current loop.

Connection terminals:

DCF 77 Output ETC 12R

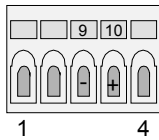

DCF 77 Output ETC 14R

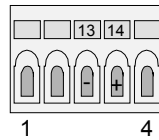

DCF 77 Output ETC 24R

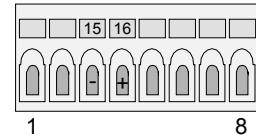

DCF 77 Output ETC 12/14/24

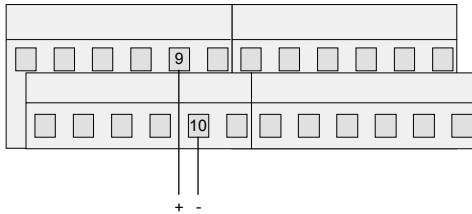

10 Synchronization – Configuration of the External Time Reference

Depending on the ETC model it is possible to synchronise the master clock from one out of eight different time sources:

	No Synch.	DCF / HBG	MSF	Min. Imp.	GPS 4500	IF482	GPS-TSIP	GPS-NMEA	CAS	CAN
ETC 12(R)	¹⁾	✓	✓	✓	✓					
ETC 14(R)	¹⁾	✓	✓	✓	✓	✓	✓	✓		
ETC 24(R)	¹⁾	✓	✓	✓	✓	✓	✓	✓	✓	✓

¹⁾ Set time manually.

The four time sources IF482, GPS-TSIP, GPS-NMEA, CAS and CAN (RS 232 only) use serial synchronisation. GPS synchronisation (TSIP and NMEA) is only possible via RS 422 interface (COM2). For IF482 and CAS synchronisation you are free to choose between the RS 232 (COM1) and the RS 422 (COM2) interface (refer to chapter 10.2).

If a time source is selected which uses serial synchronisation the communication parameters (Baudrate, Parity, Stop Bit, Data Bit) for the corresponding interface are set automatically. The settings for COM1 and COM2 interface can be checked in the Serial Communication Menu (refer to chapter 13).

It is only possible to use one serial interface (COM1 or COM2) as a time source input at the same time.

10.1 Time Source

Select the external time source (time reference).

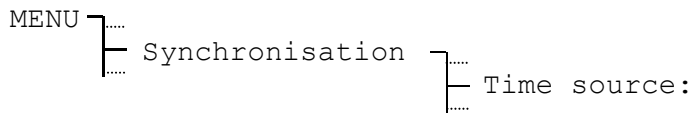

Select from: **None, DCF, MSF, Minute Impulses, GPS4500, GPS-TSIP, GPS-NMEA, IF482, CAS and CAN.**

For definitions of the **NMEA** and **IF482** protocols, see Annexe E.2 and E.3.

For the synchronisation with **minute impulses**, an additional optocoupler interface (art. no. 118922) is necessary, see also Chapter 8.6.

The time source must be selected prior to setting the associated time zone (Chapter 10.5).

10.2 Interface

Choice of the serial interface for the time sources **IF 482** or **CAS**.

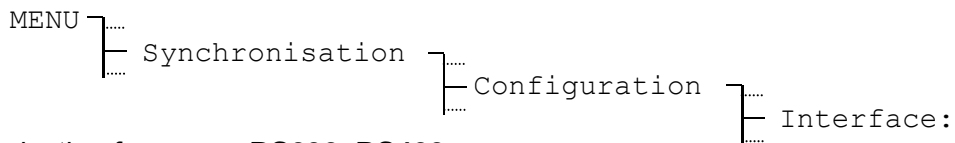

Selection from: **RS232, RS422**

10.3 Baudrate Mode (only with CAS synchronisation)

Choice of baudrate determination in case of synchronisation through CAS protocol.

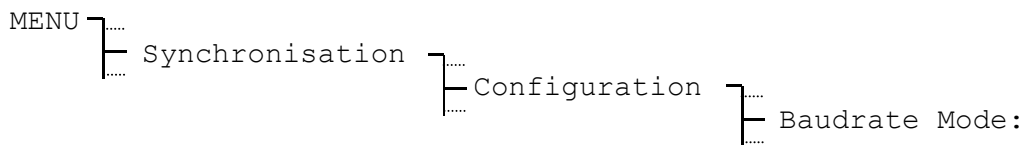

Selection from: **Auto, Manual**

In **Auto** mode the ETC tries to determine the baudrate of the CAS master automatically. This process can last for some minutes.

10.4 Baudrate (only with CAS synchronisation)

Selection of the baudrate in case of synchronisation through CAS protocol.

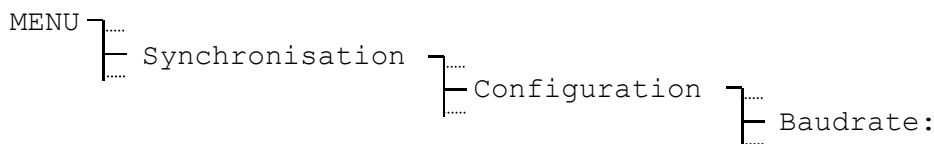



Possible Selection: **1200, 2400, 4800, 9600, 19200 Bit/s**

10.5 Time Zone

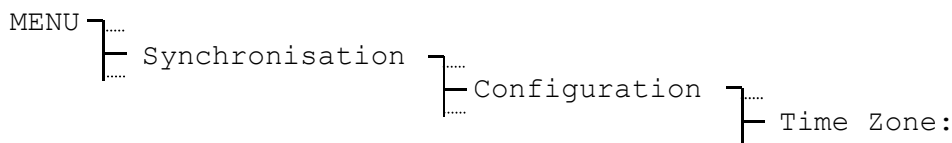
Specify the time zone of the time source.



A time zone is suggested in line with the selected time source. E.g. when selecting **DCF** as time source the time zone 02 for Central European Time will be suggested.

The cursor keys  /  are used for selection from the 100 possible entries, or the time zone can be selected by means of a numerical input.

10.6 Synchronisation Only

When this setting is activated, the external time source can only set the internal master clock time, where the difference between the time source and the internal master clock is between +/- 1 second and +/- 30 seconds. If the difference is between 0 and 1 second, the internal master clock will be adjusted to the time source in steps of +/- 10 ms per received time telegram. Automatic daylight saving time changeovers are not affected by this setting.



Notice: After first synchronization of the ETC, it is recommended to activate the function 'Synchronization only' to avoid time jumps.

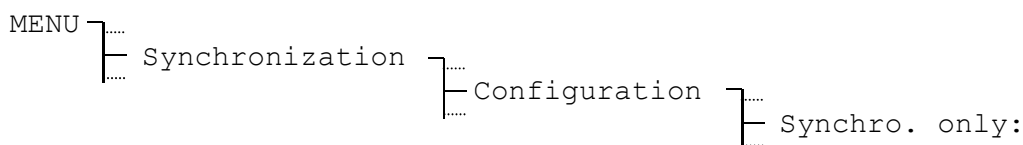

Selection from: **Yes or No**

10.7 Alarm Timeout

Setting the time until an alarm is given, where no valid time can be received from an external time source. For example, with a distorted signal from the time signal receiver.

```
MENU }  
      }  
      } Synchronisation }  
      } Configuration }  
      } Al.timeout [min]:
```

Input range: **1 to 9999 minutes**

10.8 System Address (only with CAS synchronisation)

Setting the system address upon synchronisation via CAS protocol.

```
MENU }  
      }  
      } Synchronisation }  
      } Configuration }  
      } System addr.:
```

Input range: **001 to 016, [01] to [10]**

This consists of a decimal input, that is displayed as hexadecimal figures in brackets.

10.9 State (only with CAN synchronisation)

Display of the current operating state of the CAN-M/S network interface.

```
00   Waiting on serial connection to ETC  
01   Serial connection to ETC established  
02   Contact over Ethernet occurred  
03   Waiting on completion of configuration  
04   Waiting on NTP synchronization  
05   Normal operation  
10   NTP synchronization lost
```

10.10 IP address (only with CAN synchronisation)

Manually input of the IP address for the CAN-M/S network interface. If a DHCP server is selected, the IP address will be allocated automatically from the DHCP server (chapter 10.14).

10.11 Subnet mask (only with CAN synchronisation)

Input of the Subnet mask for the CAN-M/S network interface. Definition of the splitting between network and host part of the IP address.

10.12 Gateway (only with CAN synchronisation)

Input of the Gateway IP address for the CAN-M/S network interface. Only if the CAN-M/S and the MTC are not located in the same network, a Gateway / Router is needed for the communication.

10.13 NTP server (only with CAN synchronisation)

Input of the IP addresses of up to two additional NTP servers available in the network. The addresses of the time sources are transmitted to the CAN-M/S network interface.

10.14 DHCP (only with CAN synchronisation)

Activation of the dynamic IP address allocation by a DHCP server for the CAN-M/S network interface. (DHCP = Dynamic Host Configuration Protocol). This setting is transmitted to the CAN-M/S network interface.

11 State – Reception Quality and Alarms

The state menu provides information about current and past alarms as well as about the reception quality of the external time reference. This menu is reached from the main window via the button  STATE.

11.1 Reception Quality

Displays the configured time source and its current quality. The range for the quality details extends from **0** to **100**.

```
STATE }
      } Reception quality
```

Example:

Time source:	DCF	- Current time source (display only)
Quality tele.:	100	- In the last 10 minutes good reception
Quality signal:	100	- Seconds marking okay
BACK		

11.1.1 Telegram Quality

The following applies to all time sources: Each read-in and valid time packet increases the value by 10. Accordingly, this value decreases by 10 for each missing or invalid time packet.

Telegram quality (resp. sync. quality) is available for all external time sources.



Notice: An ideal figure for telegram quality is 100. All other figures greater than 60 are however adequate for reliable synchronization.

11.1.2 Signal Quality

For all time sources: With every read in of the seconds mark, this figure increases by 1. This figure reduces accordingly by 1 for every missing seconds mark.

Signal quality (resp. valid time telegrams) is available from the following time sources: **DCF, MSF, GPS4500, GPS-TSIP and GPS-NMEA.**

11.2 Alarms

The current and stored alarms are listed under this item.



- Current alarms:* Announcement of a currently active alarm in the system.
- Stored alarms:* Alarms, which are occurred at least once since the last alarm clear. A stored alarm can still be active, or already removed.
- Alarm masking:* A masked alarm is suppressed and will, depending on the masking, not affect the display and the alarm contact or the CAS/CAN communication.

11.2.1 Alarm overview

The ETC is able to generate up to 16 different alarms depending on the device type. Those alarms are identified by the letters A to P.

A	Failure of external time reception: Within the configured alarm timeout (Chapter 10.7), no valid time package was received from the external time source.
B	Internal hardware error
C	Checksum of the saved configuration data is incorrect
D	Error in the automatic quartz trimming: External time source is imprecise or internal quartz is faulty. Error is automatically reset as soon as the deviation from the external time source to the internal quartz sinks again below 50 ppm.
E	Mains power failure
F	Automatic shut down of slave clock line 1 due to overload or short circuit
G	Automatic shut down of slave clock line 2 due to overload or short circuit
H	High current limit exceeded on slave clock line 1
I	High current limit exceeded on slave clock line 2
J	Low current limit under-run on slave clock line 1
K	Low current limit under-run on slave clock line 2
L	Battery voltage low
M	Supervision alarm external device, control input 1
N	Supervision alarm external device, control input 2
O	Supervision alarm external device, control input 3
P	Reserved

11.2.2 Alarm Display

The alarms are displayed on the ETC as follows. As an example there are two current alarms shown (mains power failure and overload line 2):

```
Current alarms
  ABCDEFGHIJKLMNOP
  ----*-*-----
BACK
```

Legend: - No alarm / alarm masked
* Alarm / Alarm not masked

11.2.3 Reset stored alarms

All occurred alarms are stored and remain in the menu "Stored alarms", even if the error is no longer active in the system. Consequently all alarms can be retraced.

The stored alarms can be reset by selecting and confirming the function **DELETE**. The time / date information in brackets corresponds to the time (UTC) of the last erasing.

```
Stored alarms
  ABCDEFGHIJKLMNOP
  ----*-*-----*----
BACK          DELETE
```

```
Reset all stored
alarms?
(11:15:42/28.02.06)
CANCEL          OK
```

11.2.4 Alarm masking

All alarms can be masked by setting the alarm mask. If a masked alarm occurs, it will be suppressed.

Mask alarm relay: - Alarm is masked. The alarm is only reported in active and stored alarms but will not be shown in the home display. The alarm relay contact of the ETC 24(R) will not switch.
* Alarm is reported in active and stored alarms and will be shown in the home display. The alarm relay contact of the ETC 24(R) will switch.

Mask CAS/CAN communication: *ETC 24(R) only*

- Alarm is masked. The alarm will not be sent to the CAS/CAN module of a MTC within the state telegram.

* Alarm will be sent to the CAS/CAN module of a MTC within the state telegram.

For changing the masks choose the function **EDIT**. Highlight the desired letter with the cursor by using the cursor keys (blinking cursor). Then press the *modify* key (arrow occurs in the display) to change the settings. Confirm the entry by pressing **OK**.

```
Alarm relay
  ABCDEFGHIJKLMNOP
  *****
BACK                               EDIT
```

```
Alarm relay
  ABCDEFGHIJKLMNOP
  ****█*****
CANCEL      ↓                       OK
```

```
Alarm relay
  ABCDEFGHIJKLMNOP
  ****_*****
BACK                               EDIT
```

Example:

An ETC with external DC power supply shall not report mains failure alarms in the home display. Therefore in above illustration the mains power alarm (E) was masked:



Notice: If menu Miscellaneous - power supply specifies Batt. as source, the mains power alarm is masked automatically and cannot be modified.

11.2.5 Alarm contact

The models ETC 24 and ETC 24R provide an alarm contact. It is open as long as at least one active alarm is present. In normal operation, without pending alarms or when an alarm is masked, it is closed.

Connection terminals:

Alarm contact ETC 24R

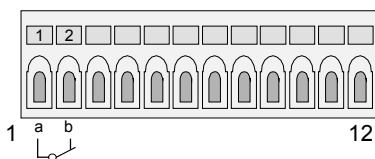

Alarm contact ETC 24

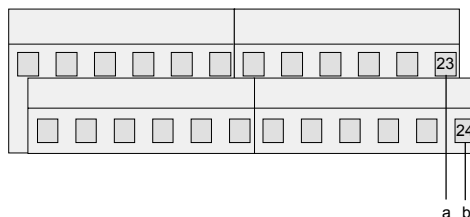

12 Slave clock lines

12.1 Line type / Terminals:

	Impulse	DCF	DCF-Imp	MOBALine	No. of lines
ETC 12(R)	✓*	✓	✓		1
ETC 14(R)	✓	✓	✓	✓*	1
ETC 24(R)	✓	✓	✓	✓*	2

Connection terminals:

* Standard settings

Slave clock line ETC 12R

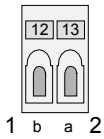

Slave clock line ETC 14R

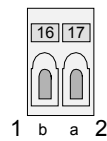

Slave clock lines 1+2 ETC 24R

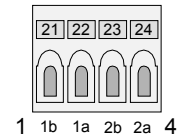

Slave clock line ETC 12/14

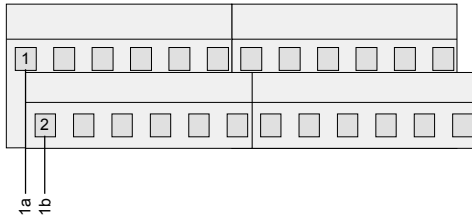

Slave clock lines 1+2 ETC 24

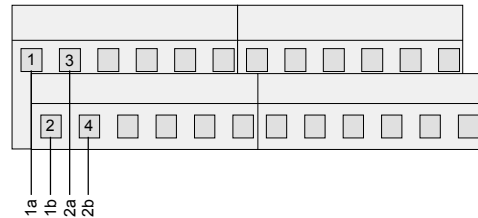

All slave clock lines can be individually configured as type "Impulse", "DCF" or "DCF-Imp". The type "Impulse" allows to output polarised 1-minute-, ½-minute-, 1/5-minute-, 1/8-minute- or 1-second-impulses (refer to 12.4.4). The type "DCF" outputs a synthetic, active – time code. You are free to choose the suitable signal from six modes (refer to 12.5.4). The line type "DCF imp" combines the output of a synthetic, active DCF 77 – time code and the function of a 1-min-impulse line with alternating impulse polarity (refer to 12.6). If your ETC is capable to output MOBALine time code for self-setting slave clocks you can further set the type to "MOBALine".

For changing the line type, you first have to enter the slave clock lines configuration menu regardless of the current mode setting. E.g. changing the line type from "Impulse" to "DCF":

```

...  ┌.....
      │..... Line x [Impulse] ┌.....
      │.....                 │..... Configuration ┌.....
      │.....                 │.....                 │..... Line type: ┌.....
      │.....                 │.....                 │.....                 │..... Impulse
  
```

The modify key **mod** is used for selection of the line type (Impulse/ DCF/ DCF-Imp/ MOBALine).

```

...  ┌.....
      │..... Line x [DCF] ┌.....
      │.....                 │..... Configuration ┌.....
      │.....                 │.....                 │..... Line type: ┌.....
      │.....                 │.....                 │.....                 │..... DCF
  
```

Confirm with the navigation key **▲▼** (OK).



Caution: You must not change the line type of a slave clock line when it is connected to the terminals of the ETC. Make sure that the used slave clocks match your line configuration settings **before** connecting the line to the terminals.



Notice: An electronic overload switch protects the output stage in case of short-circuits on the line.

12.2 Active Line Current Supervision

The model ETC 24(R) provides an active current supervision for its two slave clock lines. For each line individually a high and a low limit can be entered. The first line of the menu shows the current value of the line current.

If the measured current exceeds the high limit or if it falls below the low limit an alarm will occur which indicates a faulty operation on the line. This kind of alarm will not shut down the line. If the current supervision is not in use, set the high limit to the maximum (refer to current allocation) and the low limit to zero.

12.3 Current Allocation

In total the model ETC 24(R) can provide 1 A (700 mA eff.) line current to its two slave clock lines. This maximum current can be split up to the two lines. E.g. if you use one line only for switching functions and the other line for feeding a high number of slave clocks you can allocate the current in the ratio 1:9.

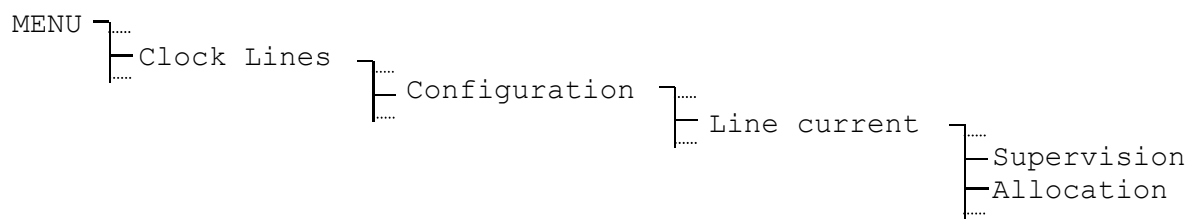

```
Supervision ┌.....
              │.....
              └─ Line 1
              └─ Line 2
```

Allocation:

Current [mA]:	0000
High Limit:	1000
Low Limit:	0000

Max. Current:	1000mA
Line 1 [%]:	050
Line 2 [%]:	050



Notice: The current allocation can affect your settings of the current supervision (limits).

12.4 Impulse Line

12.4.1 Change of the Line State

Sets the line state of the pulse line:

```
MENU }
      |
      |--- Clock Lines }
      |                |
      |                |--- Line x [Impulse] }
      |                |                    |
      |                |                    |--- State:
```

Selection from: **stop, run, 12:00**

In state *Stop* there's no pulse output (pulse line stopped). The state *Run* shifts the pulse line in normal operation (pulse output as set in the configuration).

In state *12:00* there's send out as many pulses as the clock is reaching the adjusted backlash periodicity. This state serves the clock to reach a defined position for maintenance:

backlash periodicity:	behaviour:
60 sec	Pulse output in backlash speed, until xx:xx:00 is reached. <i>(function insignificant).</i>
12 h	Pulse output in backlash speed, until 12:00 is reached.
24 h	Pulse output in backlash speed, until 00:00 is reached.
1 week	<i>(function insignificant)</i>

12.4.2 Line Time

In order to be able to set the slave clocks of an impulse line onto the master clock time, the line must first be stopped (state: stop), then all the hands of the slave clocks must be set to the same position. Set the line time manually to the time displayed on slave clocks (see menu below) and start the line again.

```
MENU }
      |
      |--- Clock Lines }
      |                |
      |                |--- Line x [Impulse] }
      |                |                    |
      |                |                    |--- Time:
```

If some slave clocks lack one step (1 second, 1/2-minute, 1/5-minute, 1/8-minute or 1 minute) the polarity of the line has to be changed at these particular clock connections. Afterwards the clocks shall be set again as per the above mentioned procedure.

12.4.3 Line Date

The line date is only important for calendar clocks with a catch-up periodicity of one week (see Chapter 12.4.7).

```
MENU }
      }
      } Clock Lines }
            }
            } Line x [Impulse] }
                  }
                  } Date:
```

In case of smaller catch-up periodicities (60s, 12h and 24h) the date will be automatically set to the master clock date and is not of importance.

12.4.4 Line Mode

Determines the output frequency of the polarised impulses.



```
... }
     }
     } Line x [Impulse] }
           }
           } Configuration }
                 }
                 } Line mode:
```

Selection from: **sec, 1/8 min, 1/5 min, 1/2 min, min**

12.4.5 Time Zone

Setting of the time zone for this output line.

```
... }
     }
     } Line x [Impulse] }
           }
           } Configuration }
                 }
                 } Time zone:
```

The cursor keys  /  are used for selection from the 100 possible entries, or the time zone can be selected by means of a numerical input.

12.4.6 Impulse Length and Impulse Pause

For the impulse length and pause the ETC proposes a standard value according to the selected line mode. These values can, however, be changed.

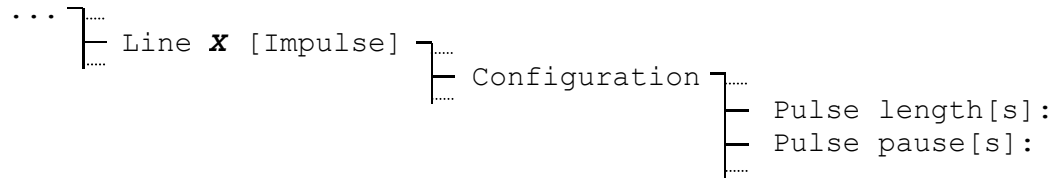

Input range: **0.2s - 0.7s**, for second lines, (sum however smaller 0.8s)
 0.2s - 5.9s, for $\frac{1}{8}$ - and $\frac{1}{5}$ -minute lines, (sum however smaller 6.0s)
 0.2s - 9.9s, for $\frac{1}{2}$ -minute and minute lines

The value of the impulse pause is only of importance in catch-up running. The following graph gives an explanation of the relations.

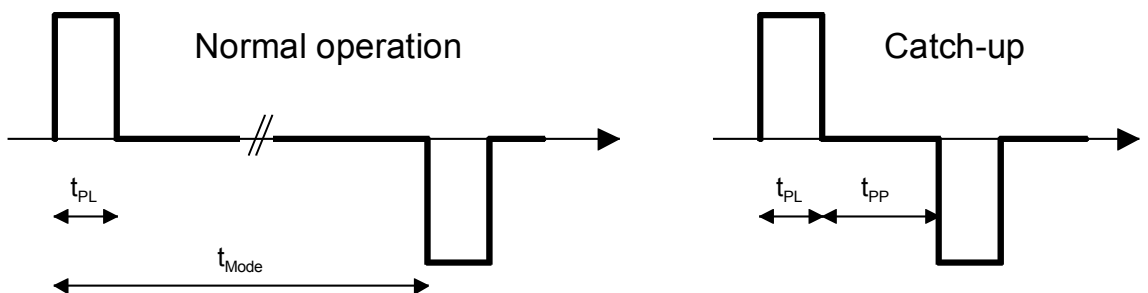

t_{PD} : Impulse length
 t_{PP} : Impulse pause
 t_{Mode} : Impulse cycle determined by the line mode (e.g. min = 1 minute)

12.4.7 Catch-up Periodicity

Determines the periodicity of the connected impulse slave clocks.

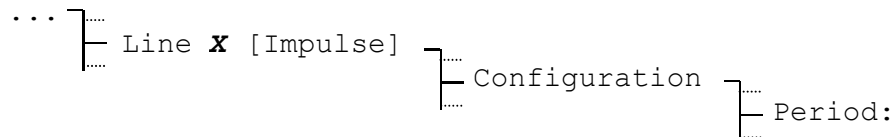

Selection from: **60 sec, 12 h, 24 h, 1 week**

12.5 DCF Output

12.5.1 Change of the Line State

```
MENU }  
      }  
      } Clock Lines }  
      }             }  
      }             } Line x [DCF] }  
      }             }             }  
      }             }             } State:
```

With each pressing of  **EDIT** the line state alternates between **stop** and **run**.

12.5.2 Line Time and Date



The displayed time can consequently not be changed and bases on the selected time zone. A stopped line will always display 12:00:00.

```
MENU }  
      }  
      } Clock Lines }  
      }             }  
      }             } Line x [DCF] }  
      }             }             }  
      }             }             } Time:  
      }             }             } Date:
```

12.5.3 Time Zone

Setting of the time zone for this output line.

```
... }  
    }  
    } Line x [DCF] }  
    }             }  
    }             } Configuration }  
    }             }             }  
    }             }             } Time zone:
```

The cursor keys  /  are used for selection from the 100 possible entries, or the time zone can be selected by means of a numerical input (refer to annexe C).

12.5.4 DCF Mode

Determines the polarity of the active DCF 77 time code.

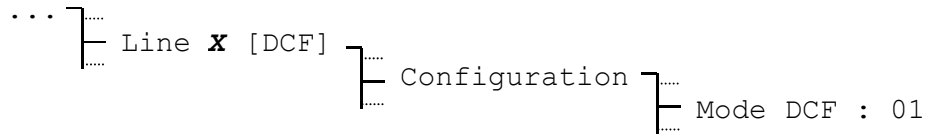

Selection from: **1, 2, 3, 4, 5, 6**

The six different modes :

Mode 1

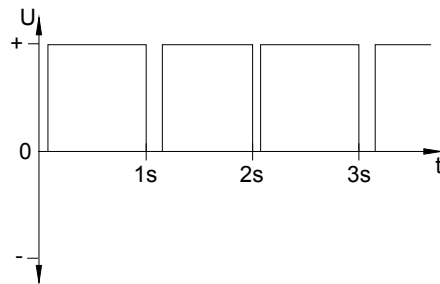

Mode 2

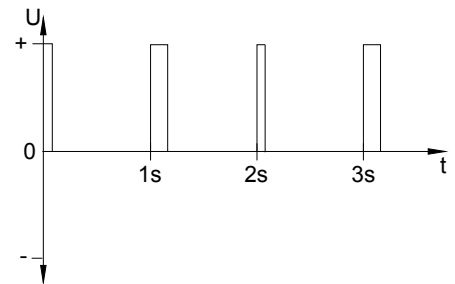

Mode 3

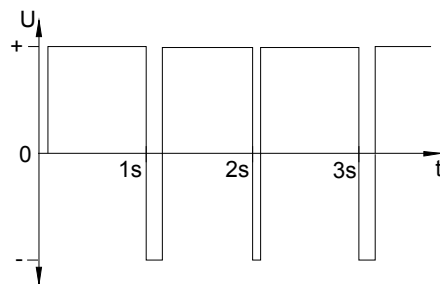

Mode 4

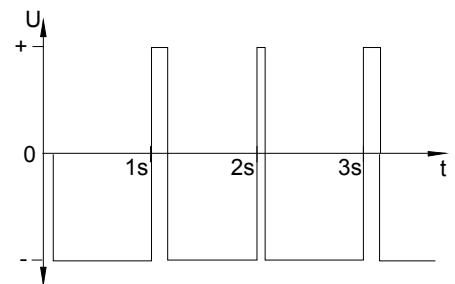

Mode 5:

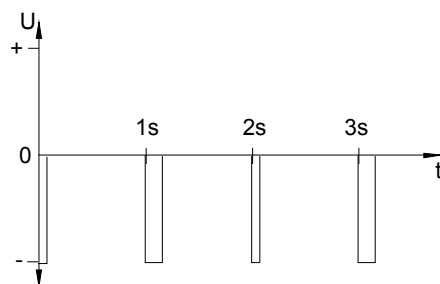

Mode 6

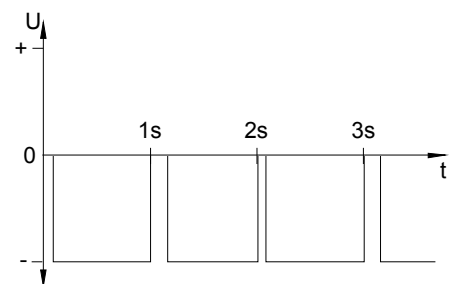

Mode 1/6, 2/5, 3/4 are equal. Their polarity only depends on how the line is connected to the ETC. The signal forms show the voltage measured from terminal b to terminal a (ETC 12(R): a to b) (refer to annexe A).

12.6 Combined DCF-Impulse Output

12.6.1 Description

With the line type "DCF-Imp" it is possible to drive minute or ½ -minute impulse clocks and self-setting Active – DCF clocks on the same line. The following line modes are possible:

Line in normal operation: DCF time code output 24V, every minute / ½-minute the polarity is changing.

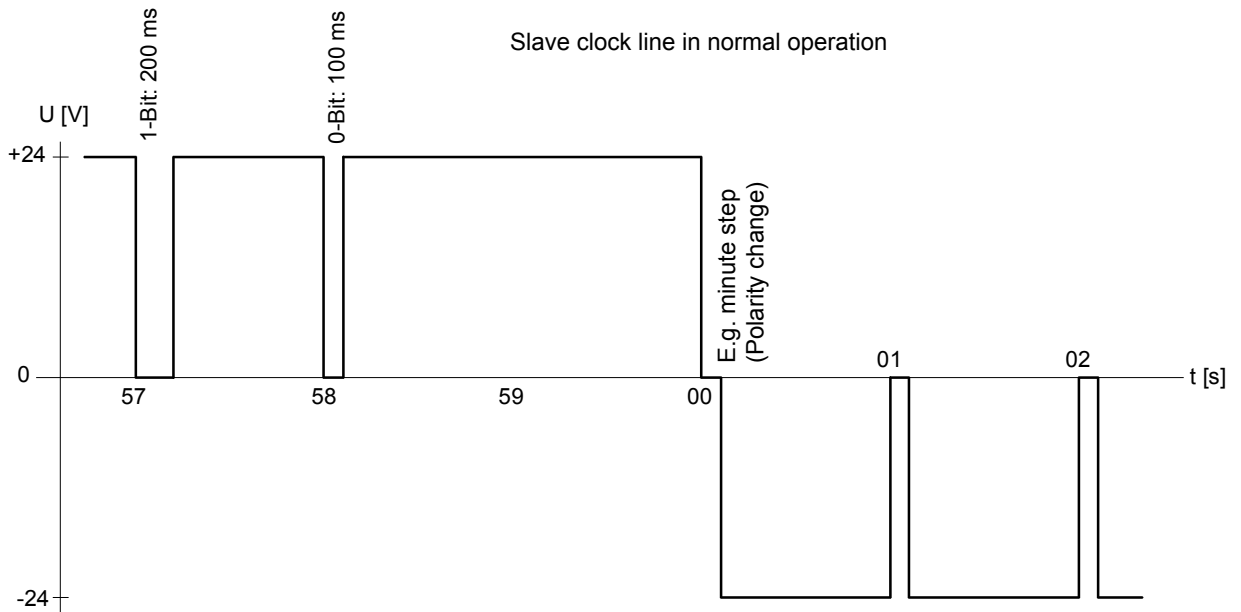

Line in catch-up mode: DCF time code output 24V, every 2 sec. the polarity is changing.

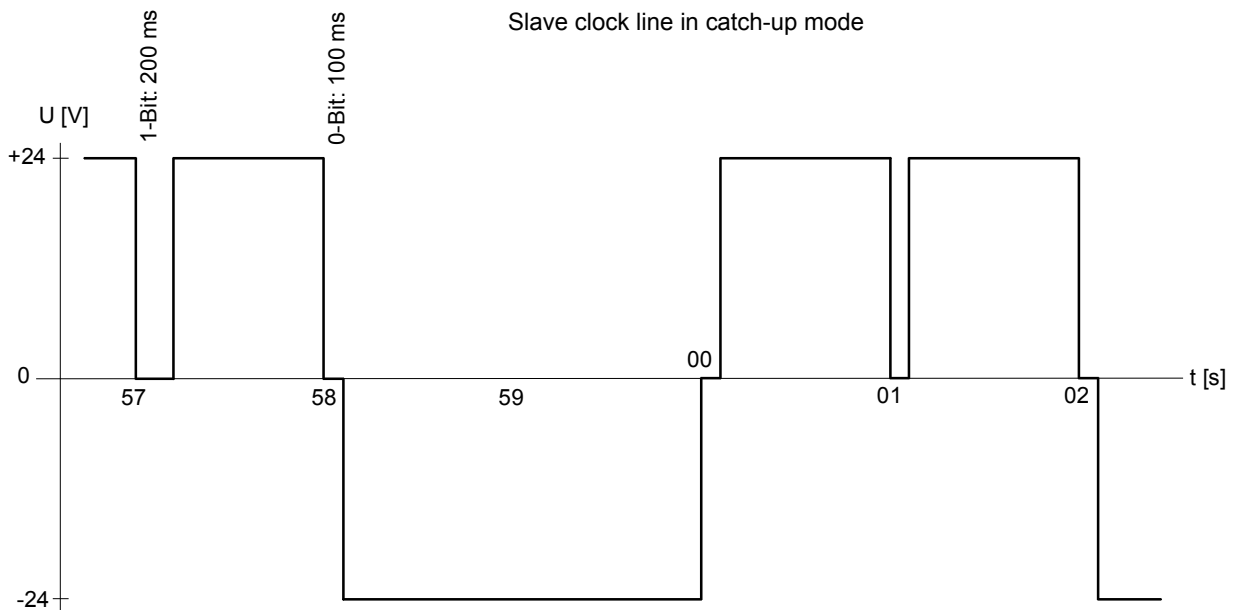

Line stopped: The output is set to mean voltage 0V.

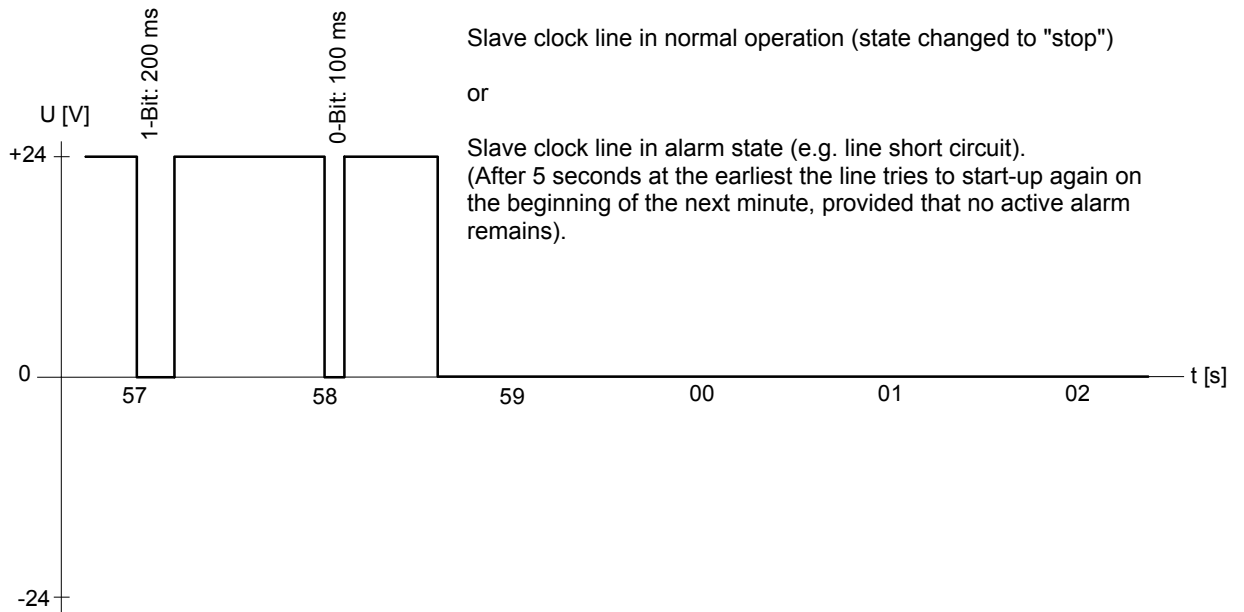

The following settings of the impulse line are fixed and cannot be modified:

- Pulse duration: 1.8 or 1.9 s
- Pulse pause: 0.2 or 0.1 s
- Catch-up periodicity: 12 hours

12.6.2 Change of the Line State

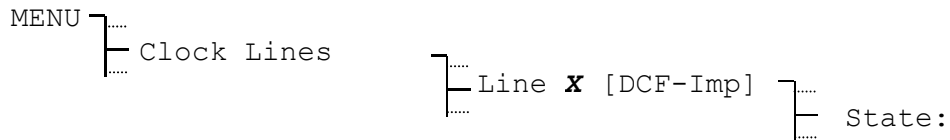

With each pressing of **EDIT** the line state alternates between **stop** and **run**. After a line was put into operation (state: run), the output of the minute impulses and DCF 77 time code will start at the beginning of the next minute.

12.6.3 Line Time

To set the slave clocks of an impulse line to the master clock time, the line must first be stopped (state: stop). Then all the hands of the slave clocks must be set to the same position. Set the line time manually to the time displayed on slave clocks (see menu below) and start the line again.

```
MENU }
      }
      } Clock Lines
      }
      } Line x [DCF-Imp] }
      } Time:
```

If some slave clocks lack one step (1 minute), the polarity of the line has to be changed at these particular slave clock connections. Afterwards the clocks shall be set again as per the above mentioned procedure.

12.6.4 Line Date



The line date is only important for calendar clocks with a catch-up periodicity of one week and is therefore not essential to set.

```
MENU }
      }
      } Clock Lines
      }
      } Line x [DCF-Imp] }
      } Date:
```

12.6.5 Time Zone

Setting of the time zone for this output line.

```
... }
     }
     } Line x [DCF-Imp] }
     } Configuration }
     } Time zone:
```

The cursor keys  /  are used for selection from the 100 possible entries, or the time zone can be selected by means of a numerical input (refer to annexe C).

12.6.6 Line Mode

Selection of **min** or **1/2 min** for the output of polarized minute or 1/2 -minute impulses.

```
... }
     }
     } Line x [DCF-Imp] }
     } Configuration }
     } Line mode:
```

The resulted impulse interval is therefore in normal operation 60, 30 seconds respectively.

12.7 MOBALine

12.7.1 Description

This operation provides the frequency modulated MOBALine code for self-setting slave clocks, channel relays and interfaces. Each line supplies time information, switching- and signal functions as well as up to 20 different time zones for the realisation of world time clocks.

The connection of the terminals is independent of the polarity.

12.7.2 Change of the Line State

```
MENU }  
      }  
      } Clock Lines }  
      }              }  
      }              } Line X [MOBALine] }  
      }              }              }  
      }              }              } State:  
      }              }              }  
      }              }              }
```

With each pressing on  **EDIT** the line state alternates between **stop** and **run**. The slave clocks of a stopped line set themselves on 12:00:00.

12.7.3 Line Time and Date

Slave clocks with MOBALine code do not have to be set manually. The displayed time can consequently not be changed and bases on the selected time zone. A stopped line will always display 12:00:00.

```
MENU }  
      }  
      } Clock Lines }  
      }              }  
      }              } Line X [MOBALine] }  
      }              }              }  
      }              }              } Time:  
      }              }              } Date:  
      }              }              }
```



Caution: The hands of a MOBALine slave clock must not be touched.

12.7.4 Line Mode

Determines the line mode resp. the running mode of the minute hand of the MOBALine slave clocks.

```
... }  
    }  
    } Line X [MOBALine] }  
    }                  }  
    }                  } Configuration }  
    }                  }              }  
    }                  }              } Line mode:  
    }                  }              }
```



Selection from: **cont., 1/2 min, min**

Please refer to the corresponding documentation of the movement.

12.7.5 Time Zone

Setting of the time zone for this output line.

```
... ]
    ] Line x [MOBALine] ]
        ] Configuration ]
            ] Time zone:
```

The cursor keys  /  are used for selection from the 100 possible entries, or the time zone can be selected by means of a numerical input.



Notice: The herein described time zone has no influence on the world time function.

12.7.6 Switch Program and World Time Function disable/enable

With the factory setting the switch program is enabled and the world time function is disabled.

Should a world time clock be realised, it is recommended to use a separate line for this application and disable the switch program on this specific line and enable the world time function.

In case of connection of channel relays the switch program needs to be enabled.

```
... ]
    ] Line x [MOBALine] ]
        ] Configuration ]
            ] Switch program:
            ] World time:
```

Selection from: **ON, OFF**

12.7.7 Definition of the World Time Zones

The world time function allows, besides the local time zone (Chapter 12.7.5), to transmit up to 20 time zones on the MOBALine code. The attribution of these world time zones is valid for all MOBALine outputs of the ETC.

```
... ]
    ] Clock Lines ]
        ] Configuration ]
            ] World time zones ]
                ] MBL time
                ] zone ZZ:
```

Example:

MBL time zone 01: 00
MBL time zone 02: 02
MBL time zone 03: 19
BACK EDIT

MOBALine world time zone 01 = 00: UTC
MOBALine world time zone 02 = 02: Brussels
MOBALine world time zone 03 = 19: Tokyo

13 Serial communication

13.1 General Description

Every ETC contains at least one serial interface RS 232 which provides different functions. The following table shall give an overview:

	COM1 RS 232 Front	COM1 RS 232 Back	COM2 RS 422
ETC 12(R)	✓	✓	
ETC 14(R)	✓	✓	✓
ETC 24(R)	✓	✓	✓

The interface COM1 can either be connected via the RJ10 front panel connector or via terminals while COM2 only can be connected via terminals.

If a cable is connected to the front connector of COM1(RJ10), the terminals using the same interface are disconnected.



Notice: RS 485 - Operation:

The interface COM2 can also be used as a RS 485 interface. In this case the terminal pairs TXD+ / RXD+ and TXD- / RXD- has to be connected together. When no data is transmitted, the interface driver always becomes tristate, even in RS 422 mode.

Requirements for the cabling (RS 422, RS 485):

- Twisted Pair cable
- Signal GND – wire necessary
- Terminating resistor of 120 Ω (at the end of the bus cable)
- Max. 32 devices on one bus
- When using cables longer than 30m, screened cable should be used.

ETC 12R:

COM 1 Interface RS 232 ETC 12R

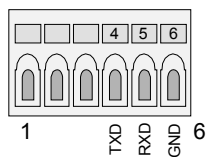

or

COM 1 Interface RS 232 ETC 12R
Front panel

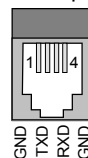

ETC 14R:

COM 1 Interface RS 232 ETC 14R

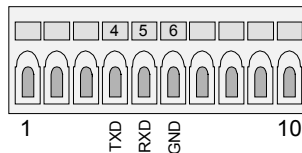

or

COM 1 Interface RS 232 ETC 14R
Front panel

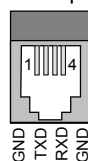

COM 2 Interface RS 422 ETC 14R

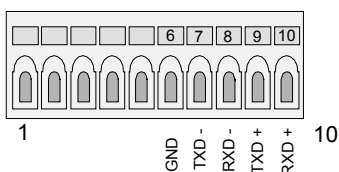

ETC 24R:

COM 1 Interface RS 232 ETC 24R

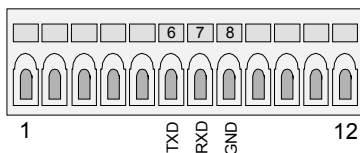

or

COM 1 Interface RS 232 ETC 24R
Front panel

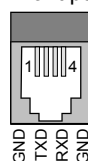

COM 2 Interface RS 422 ETC 24R

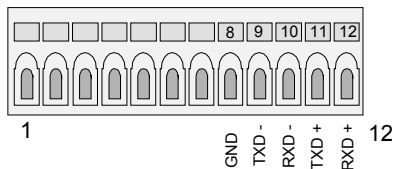

ETC 12/14/24:

COM 1 Interface RS 232 ETC 12/14/24

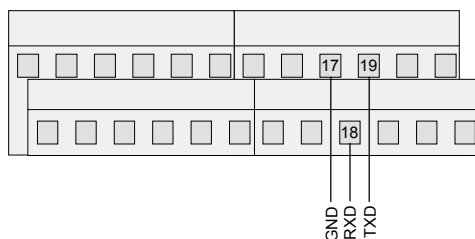

or

COM 1 Interface RS 232 ETC 12/14/24
Front panel

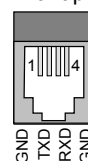

ETC 14/24:

COM 2 Interface RS 422 ETC 14/24

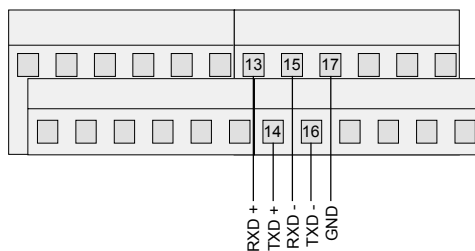

13.2 Parameters / Operating modes

13.2.1 Line Time and Date

The displayed time and date cannot be changed and is based on the selected time zone of this line.

```

MENU }
     }
     } Serial comm. }
     }              }
     }              } Port COM X [RSXXX] }
     }              }                    }
     }              }                    } Time:
     }              }                    } Date:
     }              }                    }
  
```

13.2.2 Line Mode

Selection of the interface mode.

```

... }
   }
   } Port COM X [RSXXX] }
   }                    }
   }                    } Mode: Off
   }                    }
  
```

	Synchronisation	Telegram Output	CAS-Communication	CAN-Communication	Remote Download
ETC 12(R)					✓
ETC 14(R)	✓	✓			✓
ETC 24(R)	✓	✓	✓	✓	✓

In start-up state all interfaces are switched off, which means that no function is selected. The table above shows the functions that can be selected by the user.

Synchronisation

There are several ways possible to synchronise the ETC using a serial interface (refer to chapter 10). When an interface is chosen for synchronising the clock in menu "Synchronisation" the text "Synch." appears in the "Serial communication" menu. Only one interface can be selected for synchronisation at the same time.

Telegram Output

This function forces the master clock to output the serial telegram format, selected in the submenu "Configuration", every second (definition in annexe F). The text "Tele." appears in the display.

CAS Communication

When selecting the function CAS-Communication, the ETC is synchronised by the CAS module of a Master Time Center MTC and is working as a sub-master clock. Further the ETC will report alarm messages to the MTC. Some parameters such as the system address must be set in menu "Synchronisation". The text "CAS" appears in the display.

CAN Communication

If the CAN communication function is selected, the ETC is synchronized from the CAN module of a Master Time Center MTC and is working as a sub-master clock. Error messages are transmitted to the MTC. The text "CAN" appears in the display.



Notice: For the CAN communication a CAN-M/S network interface has to be connected to the serial interface RS 232. The communication parameters may not be changed manually and they have to be 19200/8/none/1.

Remote Download

In menu "File manager" it is possible to activate the function "Remote download". This allows you to have a permanent link between the ETC and a remote computer and thus to start downloading files (season tables, switch programs, system software) at any time. The text "Remote dld." appears in the display. This function is only available for the RS 232 interface COM 1.

If the mode of an interface has been changed, the corresponding standard communication parameters will be set automatically (Exception: telegram output). Nevertheless it is possible to change the communication parameters for each interface manually in the interface's configuration menu (refer to chapter 13.2.4).

	Baudrate:	Data Bits:	Stop Bits:	Parity:
CAS Comm. ¹⁾	19200	8	1	None
CAN Comm.	19200	8	1	None
Remote Dld.	19200	8	1	None

¹⁾ In menu "Synchronisation" it is possible to activate a function for automatic baudrate detection while CAS communication is running (chapters 10.3).

The communication parameters in mode "Synchronisation" depend on the selected time source but will be set automatically, too.

	Baudrate:	Data Bits:	Stop Bits:	Parity:
GPS TSIP	9600	8	1	Odd
GPS NMEA	4800	8	1	None
IF 482	9600	7	1	Even



13.2.3 Time Zone

Setting of the time zone.

```

...
┌-----┐
│ Port COM X [RSXXX]
└-----┘
┌-----┐
│ Configuration
└-----┘
┌-----┐
│ Time zone: 00
└-----┘

```

The cursor keys  /  are used for selection from the 100 possible entries, or the time zone can be selected by means of a numerical input.

13.2.4 Communication Parameters

Defines the communication parameters for the data transmission.

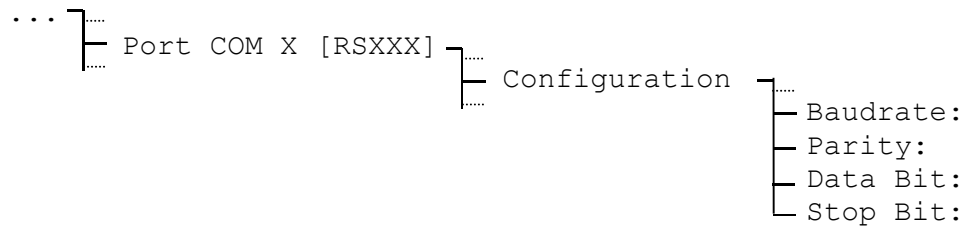

Baudrate: **300, 600, 1200, 2400, 4800, 9600, 19200 Bit/s**
Parity: **even, odd, none**
Data bit: **7, 8**
Stop bit: **1, 2**



Notice: CAS communication is only possible with one of the following baudrate settings: 1200, 2400, 4800, 9600 or 19200 Bit/s. CAN communication is only possible with the settings 19200/8/none/1.

13.2.5 Telegram Format

The selected telegram format (menu "Configuration") is output every second, when interface mode is set to telegram output ("Tele."). The following telegram formats are available (definition in annexe F):

IF482	17 characters
DIEM	24 characters
SINEC	32 characters
H7001	18 characters
BUS485	20 characters (only for RS 422 interface, hexadecimal-format)

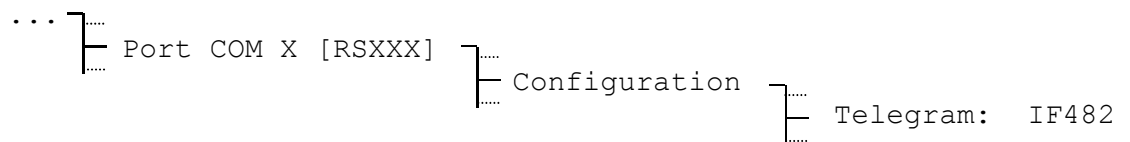

13.2.6 Telegram Send Offset

The output process of all telegram formats starts at the beginning of each second. As the second designated in the telegram is 0, the content of the telegram is valid at the beginning of the telegram. If the content of the telegram should be valid at the end of the telegram, a send offset has to be set. (The time designated in the telegram does not change thereby, the second is still 0).

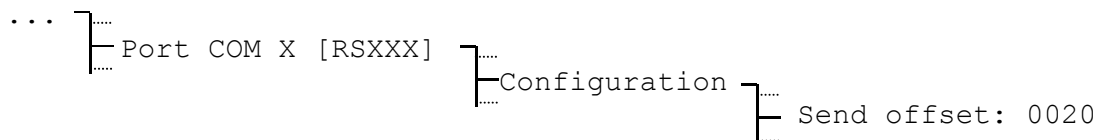

The unit of the send offset are milliseconds. The value can be set in steps of 5 milliseconds (with automatic rounding up and rounding down). The maximum send offset value is 700 ms. The following table can be used to determine the transmission duration and the corresponding send offset for the selected telegram format:

Data Bit:	7				8			
Parity:	none		odd / even		none		odd / even	
Stop Bit:	1	2	1	2	1	2	1	2
Baudrate:	Milliseconds per sent character:							
300 Bit/s	30.00	33.33	33.33	36.67	33.33	36.67	36.67	40.00
600 Bit/s	15.00	16.67	16.67	18.33	16.67	18.33	18.33	20.00
1200 Bit/s	7.50	8.33	8.33	9.17	8.33	9.17	9.17	10.00
2400 Bit/s	3.75	4.17	4.17	4.58	4.17	4.58	4.58	5.00
4800 Bit/s	1.88	2.08	2.08	2.29	2.08	2.29	2.29	2.50
9600 Bit/s	0.94	1.04	1.04	1.15	1.04	1.15	1.15	1.25
19200 Bit/s	0.47	0.52	0.52	0.57	0.52	0.57	0.57	0.63

Example:

A telegram of the format IF 482 (length: 17 characters) shall be valid at the end of the transmission. The communication parameter are: 9600 Bit/s, 7 data bit, 1 stop bit, even parity.

Send offset [ms] = 17 x 1.04 ms = 17.68 ms

(The calculated value will be rounded to +20 ms, i.e. the telegram will be sent in advance at millisecond 980).

If the telegram shall be valid at the beginning of the transmission, the send offset has to be set to 0.



Attention: The transmission time of the telegram has to be shorter than one second, otherwise the content of the telegram can be invalid. In this case select a higher baudrate.

13.2.7 Period

With this parameter the send period of the serial telegrams can be selected between every second (sec.) and every minute (min.).

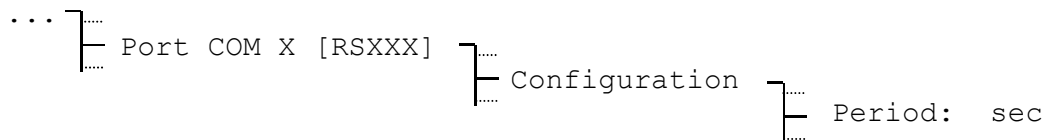

Period: **sec, min**

14 Relays

The different ETC models contain up to 4 relays with switching contacts. The relays can each be allocated to one of the 64 switch program channels independently from the other relays. Manual operation of the relays is possible through the channel monitor (chapter 15.5). Technical data of the contacts can be found in annexe H.

The illustrated contact position correspond to the idle position (OFF).

	Relays
ETC 12 (R)	2
ETC 14 (R)	4
ETC 24 (R)	4

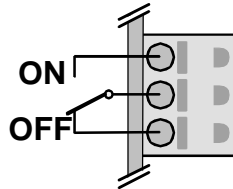

14.1 Switching States

The states of all 4 relays are assembled on one display.

MENU }

 } Relays

 }

Rel 1=OFF	Rel 3=OFF
Rel 2=OFF	Rel 4=OFF
08:48:01	05.11.02
BACK	CONFIG.

14.2 Channel Assignment

The assignment of the switch program channels to the relays can be defined on choice.

... }
 } CONFIG. }
 } Relay 1 =>Channel:
 } Relay 2 =>Channel:
 } Relay 3 =>Channel:
 } Relay 4 =>Channel:

Input range: **01 – 64**, corresponds to the channel number of the switch program
00, relay not assigned (state remains unchanged)

15 Switch Program

15.1 General Description

The switch program is composed of 99 week programs and 64 channel programs.

The week programs describe the behaviour during one week, independent of date and channel number. Such a week program can contain numerous lines and each line is composed of time of the day, days of week as well as the switching function to be executed at this moment. The 3 possible switching functions are: ON, OFF, Signal 01 – 99 Seconds.

Now the channel programs assign the week programs to the channels, which are dependent on the date. Such a channel program can contain several lines. Each line is composed of the starting date and the number of the week program to be used.

Up to 1000 lines can be programmed in this way. This is the total sum of the lines in the week and channel programs.

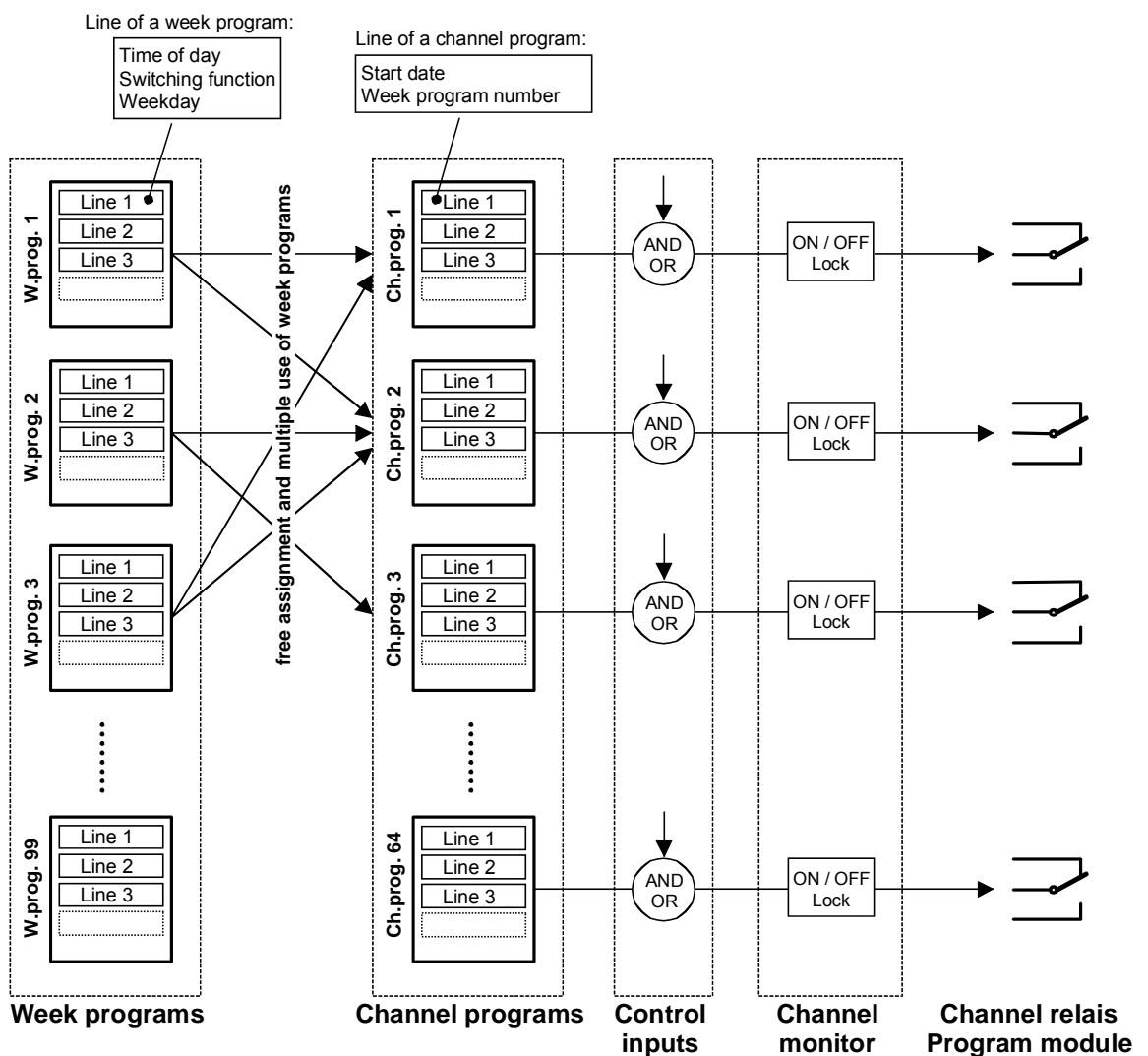

Each of the 3 control inputs can be connected with a channel by a AND- or OR combination, i.e. for twilight switch.

The channel monitor offers the possibility to recall the status (ON, OFF) of individual channels, as well as the manual on-off switching of the same. Moreover, a locking allows the freezing of the status of a channel, the status will then not be overwritten by the channel program.

The switch program can be established and edited through the menu guidance. With the PC software "SwitchEditor" the switch programs can also be worked out on the PC and then be downloaded on the ETC master clock by means of the ETCW software.

15.2 Simplified channel relay operation

Operating principle for simplified manual toggling of the channels 1-3.

Illustration 1: Home screen

```
11:11:30    Tuesday
19:02:13    Winter
STATUS      MENU
```

Push Modify.

Illustration 2: Device information

```
EuroTime Center
ETC 14
ZURÜCK
```

Push Modify.

Illustration 3: Switching status channels 1-3

```
1:ON/locked
2:OFF/not locked
3:OFF/locked
```

Using the buttons 1, 2 and 3, the mode of the respective channel (1-3) is toggled.

The following channel states are rotated through when pushing the respective channel number:

OFF / not locked - ON / not locked - OFF / locked - ON / locked

Using the Home button, the device returns to the normal menu.

15.3 Week Programs

15.3.1 Description

For many applications a simple week program will be sufficient. As a default setting, the Week program is assigned to corresponding channel. As an example: Week program 01 is assigned to channel 01, Week program 04 to channel 04, etc.

The Week program editor can be called:

```
MENU }
      |
      | Switch program }
      |                 |
      |                 | Weekly program
      |                 |
      |                 |
      |                 |
```

The display will only show one line with indication of the number of the week program (01 – 99) and the line number within the week program.

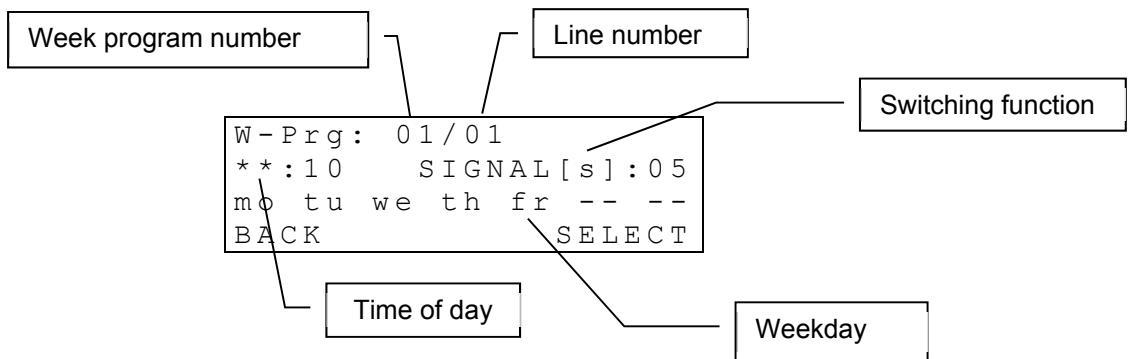

The line entries of a week program are arranged as per the time of the day.

The modification, erasing or addition of a line entry is described in the following chapter. The access will follow as described below (flashing marks in **bold**):

```
W-Prg: 01/01
*:10    SIGNAL[s]:01
mo tu we th fr -- --
BACK    SELECT
```

Choice of week program (01..99) through cursor keys / or numerical entry. Selection by (SELECT).

```
W-Prg: 01/01
**:10    SIGNAL[s]:01
mo tu we th fr -- --
BACK    SELECT
```

Selection of the line within the week program through cursor keys / . The current line appears in the display. Elaboration through (FUNCTION).



```
New entry
Edit entry
Delete entry
BACK    SELECT
```

For selection of further procedure, see following chapter.



15.3.2 Insert a New Line Entry

Inserts a new line to the selected week program. The lines will then be arranged as per the time of day.



```
New          W-Pr g : 01 / * *
* * : * *          O F F
- - - - -
C A N C E L          O K
```

Entry of time of the day through *** 0 ... 9**, resp. ** as space holder, see example Chapter 15.7. Further with cursor key  / .

```
New          W-Pr g : 01 / * *
1 2 : 1 5          O F F
- - - - -
C A N C E L      ↓          O K
```

Selection of the switching function (OFF, ON, SIGNAL[s]) through *modify-key* **mod**. Further with cursor key  / .

```
New          W-Pr g : 01 / * *
1 2 : 1 5      S I G N A L [ s ] : 0 1
- - - - -
C A N C E L          O K
```

Entry of signal duration (01 – 99 seconds) through *** 0 ... 9** (only in case of signal function). Further with cursor key  / .

```
New          W-Pr g : 01 / * *
1 2 : 1 5      S I G N A L [ s ] : 0 1
m o t u w e t h f r - - - -
C A N C E L          O K
```

Selection of the active week days through direct selection keys *** 0 ... 9**. Acknowledgement with  (OK).



Notice: With the cursor keys  /  jumping within the entry mask is possible.



15.3.3 Edit a Line Entry

```
Edit          W-Pr g : 01 / 0 1
1 2 : 1 5      S I G N A L [ s ] : 0 1
m o t u w e t h f r - - - -
C A N C E L          O K
```

The selected line appears in the display and can be arranged as described above and stored with  (OK). The lines will then be arranged as per the current the time of day.

15.3.4 Delete a Line Entry

```
Delete?      W-Pr g : 01 / 0 1
1 2 : 1 5      S I G N A L [ s ] : 0 1
m o t u w e t h f r - - - -
C A N C E L          O K
```

The selected line appears in the display and can be deleted with  (OK). Cancel with  (CANCEL).

15.4 Channel Programs

15.4.1 Description

In case of complex applications the channel programs combine different week programs according to the date. Channel program:

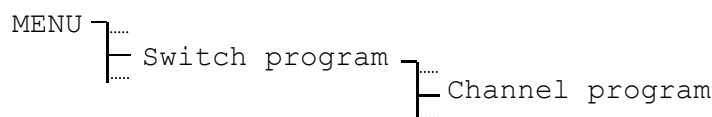

Two lines will appear in the display. The indications of the channel program and line numbers refer to the flashing display line.

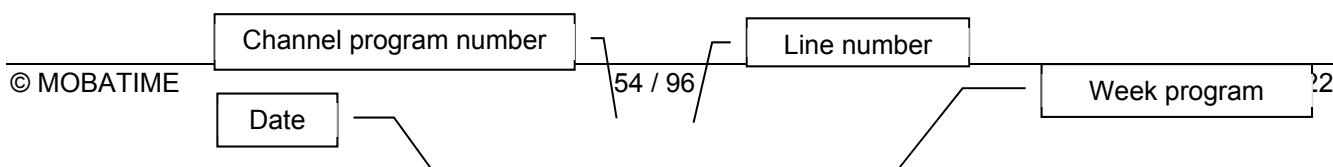

```

C-Pr g : 01 / 01
19.07.06      W-Pr g : 01
23.11.06      W-Pr g : 03
BACK          SELE CT

```



The line entries of a channel program are arranged as per date.

The changing, deletion or insertion of a line entry is described in the following chapter. The access follows as described below (flashing characters are marked in **bold**):

```

C-Pr g : 01 / 01
19.07.06      W-Pr g : 01
23.11.06      W-Pr g : 03
BACK          SELE CT



```

Choice of a channel program (01..64) through cursor keys  /  or numerical entry. Selection by  (SELECT).

```

C-Pr g : 01 / 01
19.07.06      W-Pr g : 01
23.11.06      W-Pr g : 03
BACK          FU NCT I ON

```

Selection of the line of the channel program through cursor key  / . Elaboration by  (FUNCTION).

```

New entry
Edit entry
Delete entry
BACK          SELE CT

```

Selection of further procedure, see following chapter.



15.4.2 Insert a New Line Entry

Inserts a new line entry to the selected channel program. The lines will then be arranged according to date again.

```

New          C-Pr g : 01 / **
** . ** . **      W-Pr g : 01
CANCEL          OK

```

Entry of the date through , resp. ** as space holder, see example Chapter 15.7. Further with cursor key .

```

New          C-Pr g : 01 / **
19.07.**      W-Pr g : 01
CANCEL          OK

```

Selection of the week program through . Acknowledgement  (OK).



Notice: With cursor keys  /  jumping within the entry mask is possible.

15.4.3 Edit a Line Entry

```

Edit      C-Pr g:01/01
19.07.**  W-Pr g:01

CANCEL                                OK
  
```



The selected line appears in the display and can be elaborated as described above and stored with  (OK). The lines will then be arranged according to the date again.

15.4.4 Delete a Line Entry

```

Delete?   C-Pr g:01/01
19.07.**  W-Pr g:01

CANCEL                                OK
  
```

The selected line appears in the display and can be deleted with  (OK). Cancel through  (CANCEL).

15.5 Channel Monitor

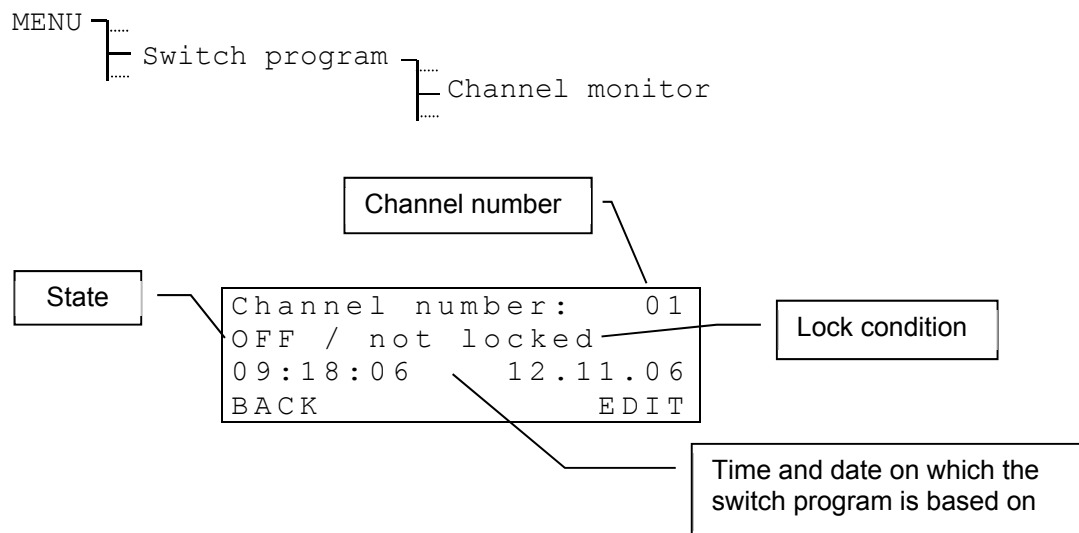

15.5.1 Description

The channel monitor indicates the current switching state of the 64 channels (ON / OFF). The channel state can be manually overwritten and locked if required. A locked channel will no more change its switching state according to the switch program.





```

Channel number: 01
OFF / not locked
09:18:06      12.11.06
BACK          EDIT
  
```

Selection of channel number (01..64) through cursor keys  /  or numerical entry. Change with  (EDIT).

```

Channel number: 01
OFF / not locked
09:18:06      12.11.06
BACK          ↓          OK
  
```

Change of the switching status and locking through the *modify* key . Acknowledgement with  (OK).

Selection from: OFF / not locked
 ON / not locked
 OFF / locked
 ON / locked



Notice: Should a locked channel be unlocked, in order to be re-introduced to the switch program again, one of the alternatives OFF / not locked or ON / not locked shall be selected. The switching state will then be adjusted to the switch program within 1 – 2 minutes.

15.6 Control Inputs

The 3 control inputs (Annexe A) permit the AND- or OR- combination of a channel with an external switch (i.e. twilight switch). The type of combination is equal for all inputs.

Potential free contact between V+ (Common) and IN 1/2/3.

Control inputs ETC 24

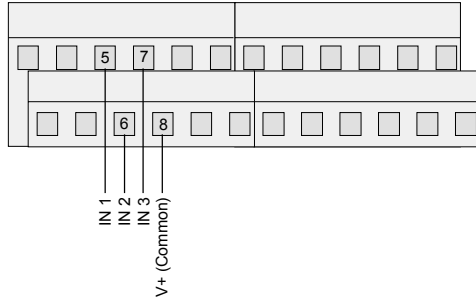

Control inputs ETC 24R

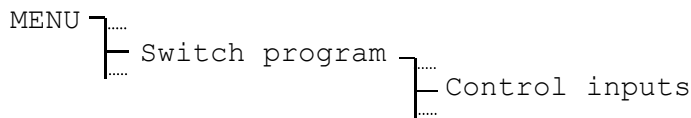
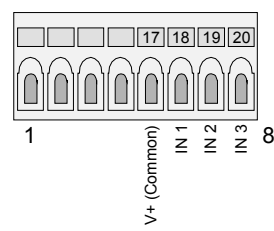

Combination:	AND
Input 1	
Input 2	
Input 3	

AND combination: The channel only switches ON, when the control input is active (closed) AND the switch program shows an ON-, or Signal command for this time.

OR combination: The channel switches ON, when the control input is active (closed) OR the switch program shows an ON-, or Signal command for this time.

Input configuration:

Function:	Prog.
State:	[OFF]
Channel:	01
Al. timeout [s]:	02

Function: Needs to be set to Prog. for using the control input to affect a channel of the switch program.

State: Shows the current state of the control input. If the control input is used for supervision of an external device the input state will be inhibited (chapter 16).

Channel: To each control input a channel can be assigned. Channel=00: Input not assigned.

Al. timeout [s]: Refer to chapter 16.

15.7 Example of a Switch Program

External illumination combined with twilight switch, switched on from 06.00 to 09.00 and from 17.00 to 21.00, Monday to Friday, the whole year.

Week program 1:

```
W-Pr g : 01 / 01
06 : 00                ON
mo tu we th fr -- --
BACK                  SELECT
```

Line 1: Switching on working days at 06:00

```
W-Pr g : 01 / 02
09 : 00                OFF
mo tu we th fr -- --
BACK                  SELECT
```

Line 2: Switching off working days at 09:00

```
W-Pr g : 01 / 03
17 : 00                ON
mo tu we th fr -- --
BACK                  SELECT
```

Line 3: Switching on working days at 17:00

```
W-Pr g : 01 / 04
21 : 00                OFF
mo tu we th fr -- --
BACK                  SELECT
```

Line 4: Switching off working days at 21:00

Channel program 1:

```
C-Pr g : 01 / 01
01 . 01 . * *          W-Pr g : 01
BACK                  SELECT
```

Line 1: The week program 01 starts every year on 1st January

Linking with twilight switch (control inputs):

```
Combination:          AND
Input 1
Input 2
Input 3
```

Channel 1 is combined with control input 1 in a AND combination. The illumination will thus only switch on at the programmed times, when the twilight switch announces 'dark'.

```
Function:              Prog.
State:                 [OFF]
Channel:               01
Al. timeout [s]:      02
```

Channel monitor:

```
Channel number:       01
OFF / not locked
09:18:06             12.11.06
BACK                  EDIT
```

The channel monitor shows the current state of channel 1. The channel shall not be locked.

16 Device Supervision

The models ETC 24 and ETC 24R provide three control inputs. These inputs can be used to control single channels of the switch program (chapter 15.6). Furthermore they can be configured to control external devices by the ETC. When the expected input signal is missing the ETC reports an alarm (to the display / alarm relay / CAS, if configured) after the timeout occurred (see example).

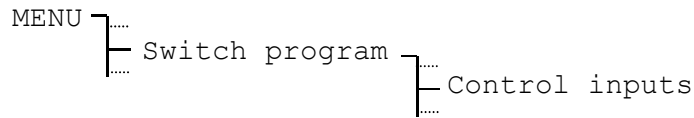

Input configuration:

Combination:	AND
Input 1	
Input 2	
Input 3	

Function:	Dyn.
State:	[---]
Channel:	00
Al. timeout [s]:	02

- Function:** Specifies the expected input signal. Selection from Low / High (signal states) or Dynamic for signals with periodically changing states (frequency approximately 10..100 Hz).
If function is set to Prog. the control input will be used for logic combination with a channel of the switch program (chapter 15.6).
- State:** The current state of the control input is inhibited as long as the input is used for device supervision ([---]).
- Channel:** Does not affect the switch program anymore as long as the device supervision is active.
- Al. timeout [s]:** Delay time in seconds (1..60 s) until the ETC indicates an alarm.

Example:

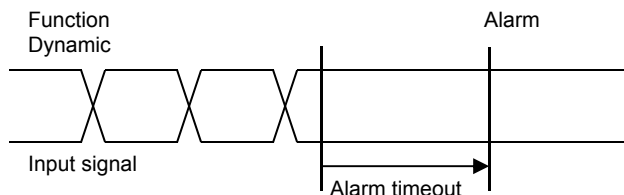

17 Data Manager – Configurations and Files

This section deals with the administration of configuration data (settings of the ETC) and the download, upload and deletion of files (download of system software, switch programs and season tables).

17.1 Administration of the Configuration Data

The current configuration data and the switch program are stored in the battery-maintained RAM and can be saved in the non-volatile flash memory and can also be loaded from this, see diagram. In addition, a function permits the loading of default configuration.

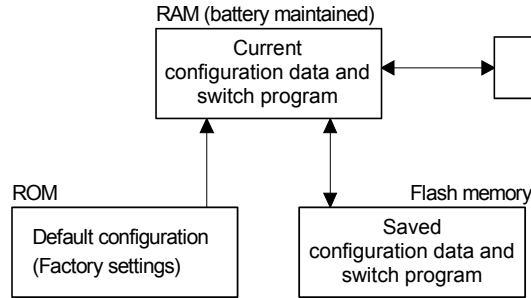

17.2 File Download in General

With the PC software ETCW, the following files can be downloaded on the ETC: system software, season table and switch programs.

The RS232 interface is used for the download. It can be contacted via the RJ10 connector in the front panel or via terminals (refer to annexe A). Both interfaces fulfil the same function. When using the interface in the front panel, the interface RS232 on the terminals is deactivated.

A manual interruption of a download from ETC's side is not possible. If the download is not started within one minute after initialisation via the menu, the ETC will revert to normal operation.

When errors occur during the download of files, these are indicated by means of an error number and text:

```

----- DOWNLOAD -----
Error:                      02
Timeout error
      (000000 Bytes)
  
```

No.	Error message	Troubleshooting
01	Communication error	Check connection
02	Timeout error	Connection interrupted or download not started
03	Checksum error	Transmission error or corrupted file
04	Wrong file	Wrong type of file selected
05	Error writing flash	Major hardware error; can only be repaired in the factory
06	Error erasing flash	
07	Wrong record type	Error in the file: system software, season table or switch program
08	Address out of range	
09	Odd address	
10	Request invalid	Error in the ETCW software

17.3 System Software

The ETC changes into the download mode and waits for a new system software through the interface.

```
MENU }.....
      |.....
      |..... File manager }.....
      |.....               |..... System software }.....
      |.....               |.....               |..... Load system-SW
      |.....               |.....               |.....
```



Notice: Prior to start a download the current configuration should be saved in the flash memory (Chapter 17.7.1). Otherwise it will be overwritten. The restoration of the saved configuration will automatically be executed after the download.

17.4 Switch Program

With the PC software SwitchEditor the switch program can be comfortably established on a PC or notebook and loaded on the ETC through the ETCW software. The switch program memory can also be deleted and uploaded through this menu point.

17.4.1 Download Switch Program from a PC

After a security inquiry the ETC changes into the download mode and waits for a switch program.

```
MENU }.....
      |.....
      |..... File manager }.....
      |.....               |..... Switch program }.....
      |.....               |.....               |..... Download program
      |.....               |.....               |.....
```



Notice: An existing switch program will be overwritten.

17.4.2 Delete Switch Program

After a security inquiry the present switch program in the RAM of the ETC will be deleted.

```
MENU }.....
      |.....
      |..... File manager }.....
      |.....               |..... Switch program }.....
      |.....               |.....               |..... Delete program
      |.....               |.....               |.....
```

17.4.3 Read Switch Program from ETC (upload)

If once it is needed to save a switch program from an ETC, or to copy it to an other ETC, you are able to read (upload) the current program. After confirming the security check, the ETC starts sending the switch program over the RS 232 interface. The used communication parameters are 19'000 Bit/s, 1 Stop Bit, no parity. To read (upload) the program file, the SwitchEditor software or a simple terminal program with capture function can be used. The received data should be saved as a *.PRG file. By means of the ETCW software, the file can be downloaded to another ETC.

```
MENU }
      } File manager      }
      }                   } Switch program }
      }                   }               } Read program
```



Notice: The RS 232 – communication parameters are **not** reset to the previous values after the upload is finished.

17.5 Time zone table

A new season table (time zone table) can be loaded on the ETC through the interface. For further information concerning the season table, see Chapter 5 and Annexe C.

17.5.1 Download Season Table from a PC

The ETC changes into download mode and waits for a new season table through the interface.

```
MENU }
      } File manager      }
      }                   } Season table }
      }                   }               } Load season table
```



Notice: The time zone entries defined by the user are placed within the season table from position 80 on.

17.6 Default Configuration

The default configuration (factory settings) will be loaded after the confirmation prompt. With this function the switch program memory and the switch program in RAM are deleted too.

```
MENU }
      } File manager      }
      }                   } Default config.
```

After the selection, the execution has to be confirmed.
A summary of the default configuration (factory settings) are listed in appendix B.

17.7 User Configuration

The current ETC configuration and the switch program can be saved in the non-volatile flash memory and loaded again from this memory. The settings are thus retained even after a software update.



Notice: It is possible, that configuration data of an old software version becomes invalid, because of larger modifications in the software. Therefore it is important to check the settings of the clock after each software update. If needed, the ETC has to be configured completely new. Don't forget to save the correct configuration into the flash memory afterwards (chapter 17.7.1).

17.7.1 Save

Saves current ETC configurations and the switch program in the flash memory.

```
MENU }
      |
      | File manager }
      |               |
      |               | User data }
      |               |           |
      |               |           | Save
```

17.7.2 Restore

Recalls saved ETC configurations and the switch program from the flash memory into the RAM.

```
MENU }
      |
      | File manager }
      |               |
      |               | User data }
      |               |           |
      |               |           | Restore
```



Notice: Loading the configuration from the flash memory into the RAM also takes place automatically after an update of the system software.

17.8 Remote Download

Where there is a connection to a PC via the RS232 interface, files (system software, switch program and season table) can be downloaded from the PC without any manipulation on the ETC. In this case, the RS232 interface is reserved exclusively for file downloads.

```
MENU }
      |
      | File manager }
      |               |
      |               | Remote download
```



Notice: If this function is switched on (YES), the RS232 interface is not available for further functions (synchronization, telegram output or CAS communication).

18 Miscellaneous

This chapter treats the adjustments concerning the display presentation, selection of language, as well as the indication of the software and hardware versions.

18.1 Language

The following languages are available: **English, German, French, Russian, Portuguese and Danish.**

```
MENU }
      }
      } Miscellaneous }
            }
            } Language }
                  }
                  } Language: English
```

18.2 Display

18.2.1 Contrast

The display contrast can be varied between **0** and **99%**.

```
MENU }
      }
      } Miscellaneous }
            }
            } Display }
                  }
                  } Contrast[%]: 50
```

18.2.2 Backlight

In the factory setting, the backlighting of the LC Display switches off after 3 minutes (**auto**). This automatic setting can also be locked (**On/Off**).

```
MENU }
      }
      } Miscellaneous }
            }
            } Display }
                  }
                  } Backlight: auto
```



Notice: When the ETC is not powered from mains (Battery / external DC power supply), only the "auto" mode is selectable.

18.3 Versions

The number and version of the currently installed software and hardware parts can be recalled under this menu item.

18.3.1 System Software

Information about the currently installed system software on the ETC.

```
MENU }
      }
      } Miscellaneous }
            }
            } Versions }
                  }
                  } System software
```

18.3.2 Core Print PCB

Information about the currently installed Core Print on the ETC.

```
MENU }  
      }-Miscellaneous }  
                        }-Versions }  
                          }-Core PCB
```

18.3.3 Basis Print PCB

Information about the currently installed Basis Print on the ETC.

```
MENU }  
      }-Miscellaneous }  
                        }-Versions }  
                          }-Basis PCB
```

18.3.4 Season table

Information about the currently installed season table on the ETC.

```
MENU }  
      }-Miscellaneous }  
                        }-Versions }  
                          }-Season table
```

18.4 Power supply

This parameter is used to define, if the ETC is powered from mains or from battery or external DC power supply respectively. Set this parameter to "Battery", if the mains power failure alarm shall be suppressed. This alarm is then automatically masked in the menu "Alarm Mask" (chapter 11.2.4).

```
MENU }  
      }-Miscellaneous }  
                        }-Power supply }  
                          }-Mains / Batt.
```



19 Maintenance

19.1 Troubleshooting

#	Malfunction / indication:	Possible causes/ actions
1	None or wrong text visible on the display (points or incomplete letters).	<p>The RAM memory area of the character set contains invalid data. Possible causes are electrical malfunctions that can arise when restarting after power outages or may be due to strong inductive switching stress of the relay contacts.</p> <p>The fault can usually be remedied by an ETC reset using the hotkeys (see description in chapter 19.2).</p>
2	ETC is completely blocked short time after start-up (only some seconds / minutes) and operation over the keyboard is not possible.	<p>A manually input switch program may cause the ETC to shut down when performed if the memory for it hasn't been initialized. Switching commands are carried out at minute changes, which is why this error often arises at the fifty-ninth second.</p> <p>Remedy: Interrupt the power supply and delete the switching program memory in RAM within the current minute using the <i>File Manager /Switch Program</i> menu.</p> <p>The current switch program is lost when this is done and must be reinput.</p> <p>Then save the switch program memory and user data into FLASH memory by entering the <i>File Manager/User Data</i> menu.</p> <p>(If this operation fails carry out, perform a reset using the hotkeys, see chapter 19.2).</p>
3	Update of the system software.	<p>The system software can be updated using the PC program ETCW and a download cable (see chapter 17.3).</p> <p>Your service office will advise you of the benefits and necessity of updates. The firmware file needed can be obtained from that office.</p>
4	Needed information to contact MOBATIME service.	<p>Device type, part number, production number and serial number: These details are given on the adhesive type label. (The device type can be queried using the mod button in the Home menu).</p> <p>Current software version: This can be queried in the <i>Miscellaneous/Versions/System Software</i> menu.</p> <p>Current and stored alarms: These can be queried using the <i>STATE/Alarms</i> menu.</p> <p>Place and date of purchase and of commissioning of the device.</p> <p>Most comprehensive possible details of the malfunction: Describe the problem, possible causes, measures taken, the system environment / operating mode and configuration, etc.</p>

19.2 Reset with Hotkey-Combination

The following procedure reset the master clock to initial state (factory settings). Current configuration and switch programs will be lost.

1. Remove power supply (mains / possibly. external battery).
2. Press and hold keys  (Selection right) and  simultaneously.
3. Switch on (connect) power supply.
4. Release keys (Home menu appears in the display).
5. Load factory configuration under menu `File manager/Default config.` (chapter 17.6).
6. Do the desired configurations / enter switch program or download a program by using SwitchEditor software.
7. When user configuration is completely done, save user data to the FLASH memory by selecting menu `File manager/User Data.` (chapter 17.7.1).

A Connection Diagrams

ETC 12R

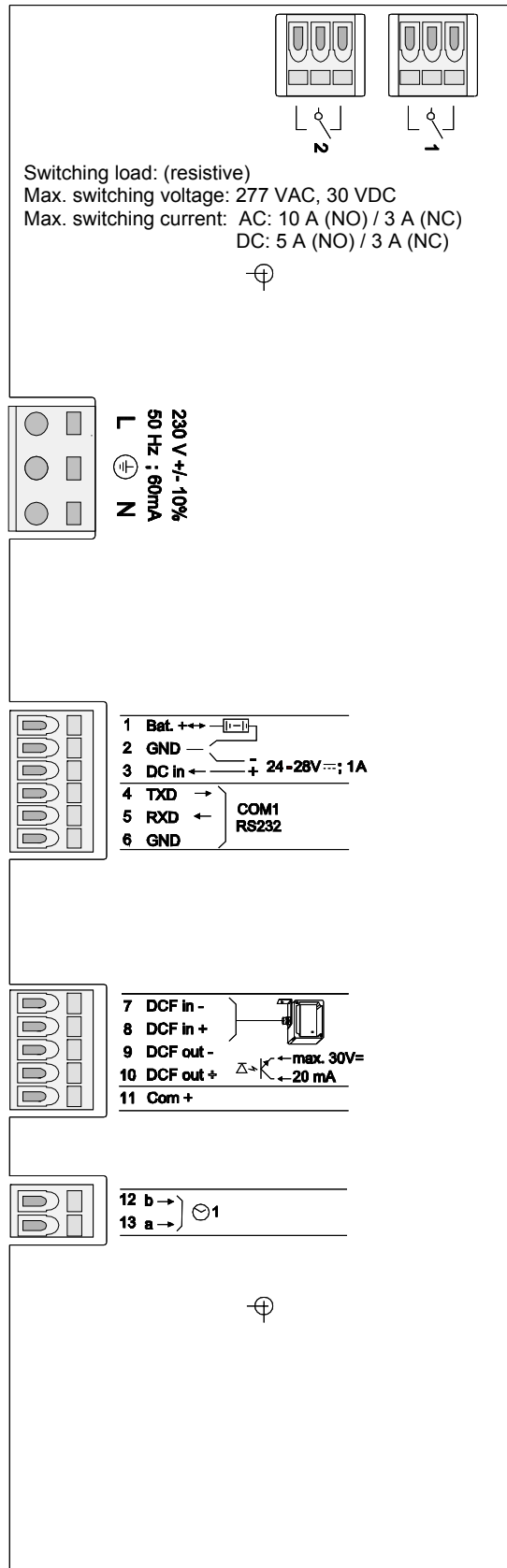

Terminals ETC 12R

Terminal	Connection	Description
1	Relay 1	Switching contact 230 VAC / 10 A ($\cos \Phi = 1$)
2	Relay 2	Switching contact 230 VAC / 10 A ($\cos \Phi = 1$)
L	Mains power phase	Mains power input safety connector. (refer to chapter 7.1.1).
	Mains power earth	
N	Mains power neutral	
1	Bat +	Input for running reserve battery (refer to chapter 7.1.4).
2	GND	Ground for battery and DC power supply
3	DC-IN +	Input for external DC power supply (refer to chapter 7.1.2).
4	RS 232 TXD	Interface RS 232 file download.
5	RS 232 RXD	
6	GND	Ground
7	DCF input -	DCF input for the connection of a DCF receiver with current loop output.
8	DCF input +	
9	DCF output -	Synthetic DCF output, opto coupler, $U_{max}=30VDC$, $I_{on}=10..15mA$, $I_{off}=2mA @20VDC$
10	DCF output +	
11	Common +	DC voltage output 22..29 VDC 200 mA max.
12	Slave clock line 1b	Output of polarised Impulses or DCF
13	Slave clock line 1a	Output of polarised Impulses or DCF

ETC 14R

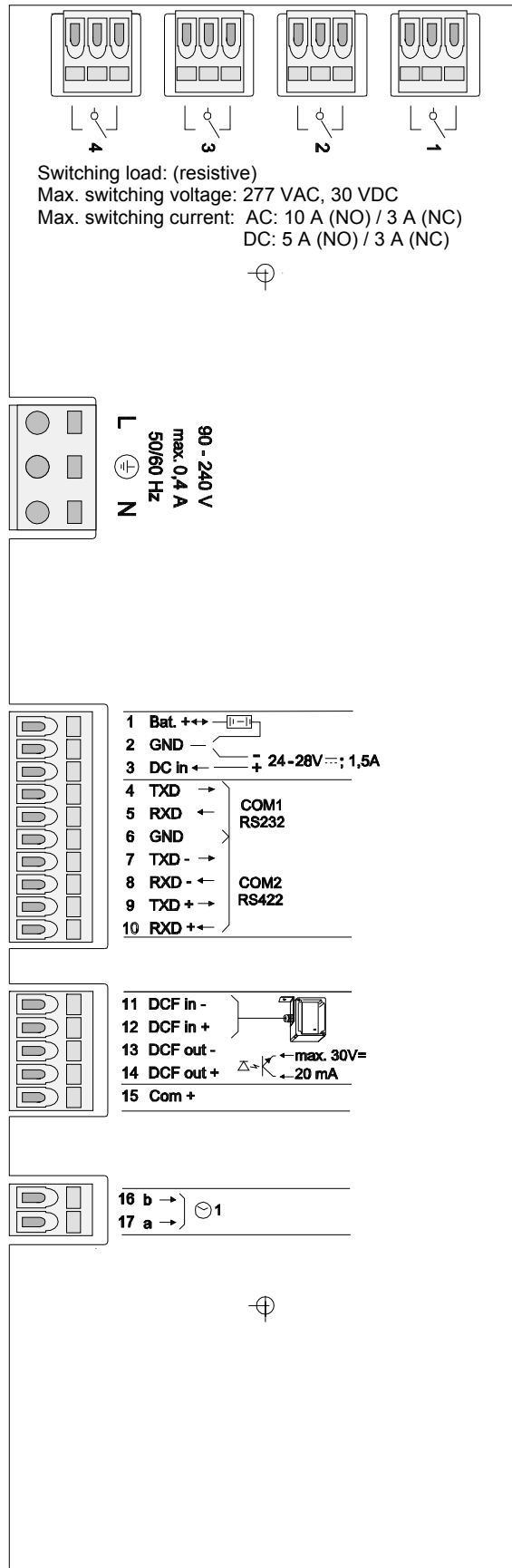

Terminals ETC 14R

Terminal	Connection	Description
1	Relay 1	Switching contact 230 VAC / 10 A ($\cos \Phi = 1$)
2	Relay 2	Switching contact 230 VAC / 10 A ($\cos \Phi = 1$)
3	Relay 3	Switching contact 230 VAC / 10 A ($\cos \Phi = 1$)
4	Relay 4	Switching contact 230 VAC / 10 A ($\cos \Phi = 1$)
L	Mains power phase	Mains power input safety connector. (refer to chapter 7.1.1).
⊕	Mains power earth	
N	Mains power neutral	
1	Bat +	Input for running reserve battery (refer to chapter 7.1.4).
2	GND	Ground for battery and DC power supply
3	DC-IN +	Input for external DC power supply (refer to chapter 7.1.2).
4	RS 232 TXD	Interface RS 232 for serial synchronisation in-/output, file download.
5	RS 232 RXD	
6	GND	Ground
7	RS 422 TXD -	Interface RS 422 for serial synchronisation in-/output.
8	RS 422 RXD -	
9	RS 422 TXD +	
10	RS 422 RXD +	
11	DCF input -	DCF input for the connection of a DCF receiver with current loop output.
12	DCF input +	
13	DCF output -	Synthetic DCF output, opto coupler, $U_{max}=30VDC$, $I_{on}=10..15mA$, $I_{off}=2mA @20VDC$
14	DCF output +	
15	Common +	DC voltage output 22..29 VDC 200 mA max.
16	Slave clock line 1b	Output of polarised Impulses, DCF or MOBALine
17	Slave clock line 1a	Output of polarised Impulses, DCF or MOBALine

ETC 24R

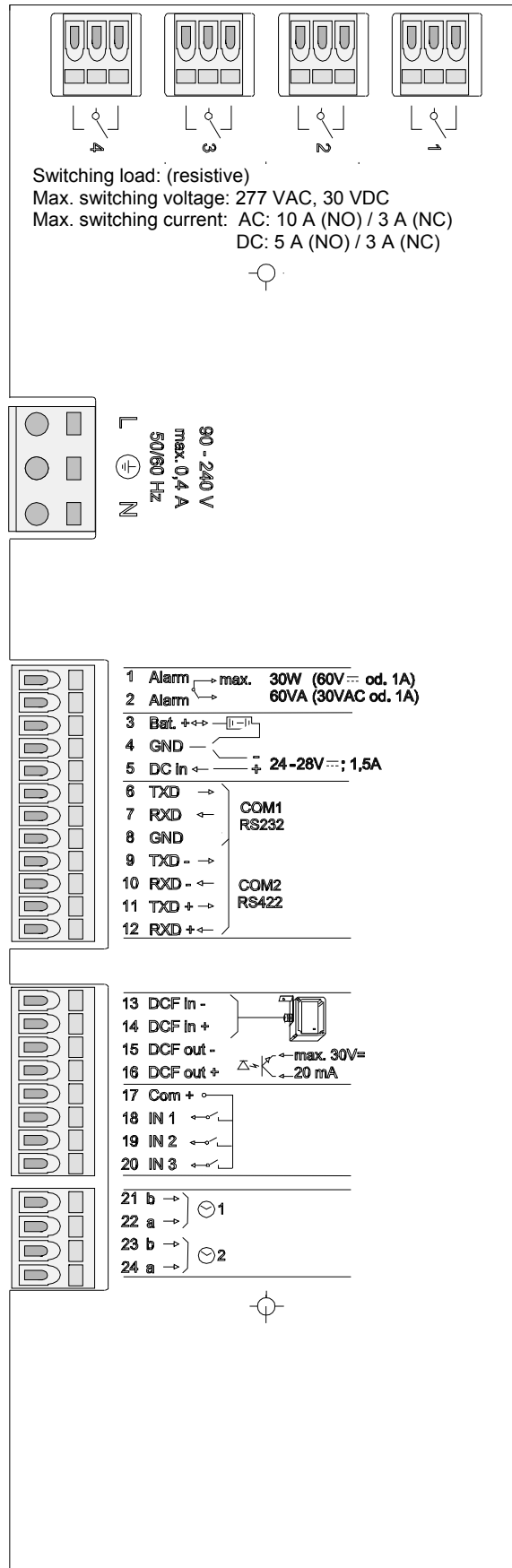

Terminals ETC 24R

Terminal	Connection	Description
1	Relay 1	Switching contact 230 VAC / 10 A ($\cos \Phi = 1$)
2	Relay 2	Switching contact 230 VAC / 10 A ($\cos \Phi = 1$)
3	Relay 3	Switching contact 230 VAC / 10 A ($\cos \Phi = 1$)
4	Relay 4	Switching contact 230 VAC / 10 A ($\cos \Phi = 1$)
L	Mains power phase	Mains power input safety connector. (refer to chapter 7.1.1).
⊕	Mains power earth	
N	Mains power neutral	
1	Alarm relay	Contact opens at alarm
2	Alarm relay	Load: 30 W (60 VDC or 1A) or 60 VA (30 VAC or 1A)
3	Bat +	Input for running reserve battery (refer to chapter 7.1.4).
4	GND	Ground for battery and DC power supply
5	DC-IN +	Input for external DC power supply (refer to chapter 7.1.2).
6	RS 232 TXD	Interface RS 232 for CAS/CAN communication, serial synchronisation in-/output, file download / upload.
7	RS 232 RXD	
8	GND	Ground
9	RS 422 TXD -	Interface RS 422 for CAS communication, serial synchronisation in-/output.
10	RS 422 RXD -	
11	RS 422 TXD +	
12	RS 422 RXD +	
13	DCF input -	DCF input for the connection of a DCF receiver with current loop output.
14	DCF input +	
15	DCF output -	Synthetic DCF output, opto coupler, $U_{max}=30VDC$, $I_{on}=10..15mA$, $I_{off}=2mA @20VDC$
16	DCF output +	
17	Common +	DC voltage output 22..29 VDC; 200 mA max.
18	Control input 1	Control inputs for twilight switch and other devices in connection with the switch program. Active when closed.
19	Control input 2	
20	Control input 3	
21	Slave clock line 1b	Output of polarised Impulses, DCF or MOBALine
22	Slave clock line 1a	Output of polarised Impulses, DCF or MOBALine
23	Slave clock line 2b	Output of polarised Impulses, DCF or MOBALine
24	Slave clock line 2a	Output of polarised Impulses, DCF or MOBALine

ETC 12

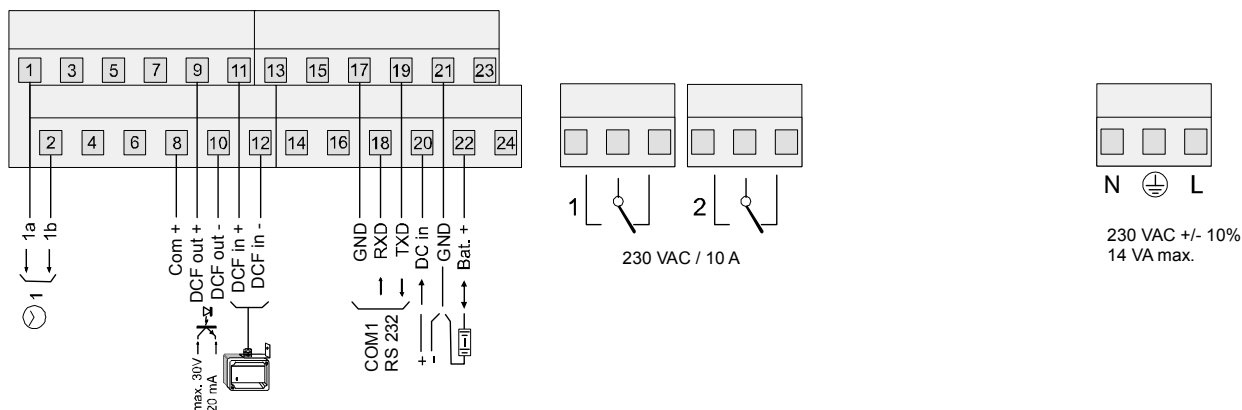

Terminals ETC 12

Terminal	Connection	Description
1	Slave clock line 1a	Output of polarised Impulses or DCF
2	Slave clock line 1b	Output of polarised Impulses or DCF
3	N.C.	
4	N.C.	
5	N.C.	
6	N.C.	
7	N.C.	
8	Common +	DC voltage output 22..29 VDC; 200 mA max.
9	DCF output +	Synthetic DCF output, opto coupler, $U_{max}=30VDC$, $I_{on}=10..15mA$, $I_{off}=2mA @20VDC$
10	DCF output -	
11	DCF input +	DCF input for the connection of a DCF receiver with current loop output.
12	DCF input -	
13	N.C.	
14	N.C.	
15	N.C.	
16	N.C.	
17	GND	Ground
18	RS 232 RXD	Interface RS 232 for file download.
19	RS 232 TXD	
20	DC-IN +	Input for external DC power supply (refer to chapter 7.1.2).
21	GND	Ground for battery and DC power supply
22	Bat +	Input for running reserve battery (refer to chapter 7.1.4).
23	N.C.	
24	N.C.	
1	Relay 1	Switching contact 230 VAC / 10 A ($\cos \Phi = 1$)
2	Relay 2	Switching contact 230 VAC / 10 A ($\cos \Phi = 1$)
N	Mains power neutral	Mains power input (refer to chapter 7.1.1).
⊕	Mains power earth	
L	Mains power phase	

ETC 14

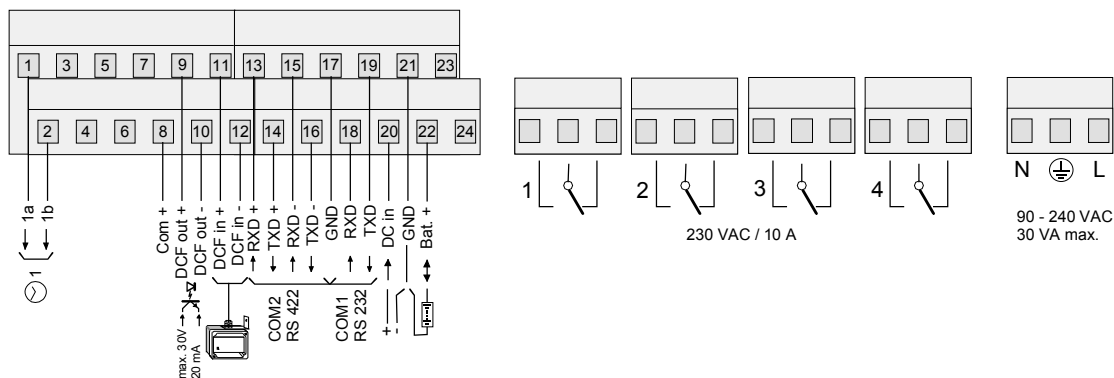

Terminals ETC 14

Terminal	Connection	Description
1	Slave clock line 1a	Output of polarised Impulses, DCF or MOBALine
2	Slave clock line 1b	Output of polarised Impulses, DCF or MOBALine
3	N.C.	
4	N.C.	
5	N.C.	
6	N.C.	
7	N.C.	
8	Common +	DC voltage output 22..29 VDC 200 mA max.
9	DCF output +	Synthetic DCF output, opto coupler, $U_{max}=30VDC$, $I_{on}=10..15mA$, $I_{off}=2mA @20VDC$
10	DCF output -	
11	DCF input +	DCF input for the connection of a DCF receiver with current loop output.
12	DCF input -	
13	RS 422 RXD +	Interface RS 422 for serial synchronisation in-/output.
14	RS 422 TXD +	
15	RS 422 RXD -	
16	RS 422 TXD -	
17	GND	Ground
18	RS 232 RXD	Interface RS 232 for serial synchronisation in-/output, file download.
19	RS 232 TXD	
20	DC-IN +	Input for external DC power supply (refer to chapter 7.1.2).
21	GND	Ground for battery and DC power supply
22	Bat +	Input for running reserve battery (refer to chapter 7.1.4).
23	N.C.	
24	N.C.	
1	Relay 1	Switching contact 230 VAC / 10 A ($\cos \Phi = 1$)
2	Relay 2	Switching contact 230 VAC / 10 A ($\cos \Phi = 1$)
3	Relay 3	Switching contact 230 VAC / 10 A ($\cos \Phi = 1$)
4	Relay 4	Switching contact 230 VAC / 10 A ($\cos \Phi = 1$)
N	Mains power neutral	Mains power input (refer to chapter 7.1.1).
⊕	Mains power earth	
L	Mains power phase	

ETC 24

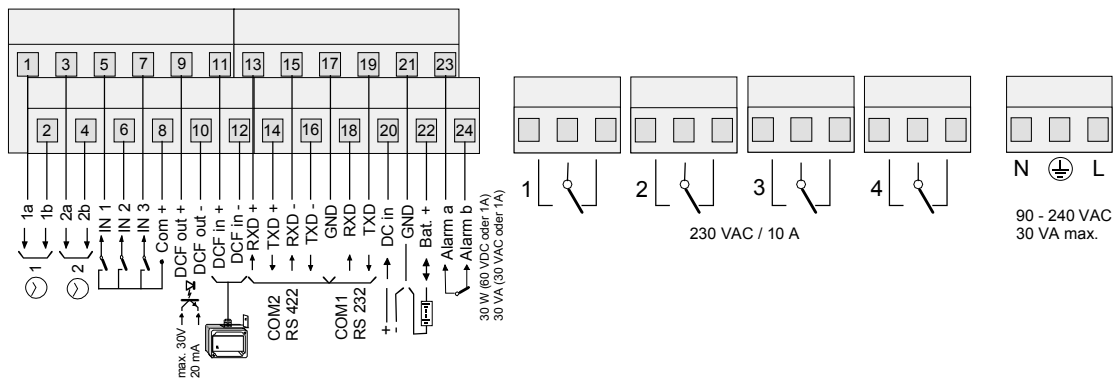

Terminals ETC 24

Terminal	Connection	Description
1	Slave clock line 1a	Output of polarised Impulses, DCF or MOBALine
2	Slave clock line 1b	Output of polarised Impulses, DCF or MOBALine
3	Slave clock line 2a	Output of polarised Impulses, DCF or MOBALine
4	Slave clock line 2b	Output of polarised Impulses, DCF or MOBALine
5	Control input 1	Control inputs for twilight switch and other devices in connection with the switch program. Active when closed.
6	Control input 2	
7	Control input 3	
8	Common +	DC voltage output 22..29 VDC; 200 mA max.
9	DCF output +	Synthetic DCF output, opto coupler, $U_{max}=30VDC$, $I_{on}=10..15mA$, $I_{off}=2mA @20VDC$
10	DCF output -	
11	DCF input +	DCF input for the connection of a DCF receiver with current loop output.
12	DCF input -	
13	RS 422 RXD +	Interface RS 422 for CAS communication, serial synchronisation in-/output.
14	RS 422 TXD +	
15	RS 422 RXD -	
16	RS 422 TXD -	
17	GND	Ground
18	RS 232 RXD	Interface RS 232 for CAS/CAN communication, serial synchronisation in-/output, file download / upload.
19	RS 232 TXD	
20	DC-IN +	Input for external DC power supply (refer to chapter 7.1.2).
21	GND	Ground for battery and DC power supply
22	Bat +	Input for running reserve battery (refer to chapter 7.1.4).
23	Alarm relay	Contact opens at alarm
24	Alarm relay	Load: 30 W (60 VDC or 1A) or 60 VA (30 VAC or 1A)
1	Relay 1	Switching contact 230 VAC / 10 A ($\cos \Phi = 1$)
2	Relay 2	Switching contact 230 VAC / 10 A ($\cos \Phi = 1$)
3	Relay 3	Switching contact 230 VAC / 10 A ($\cos \Phi = 1$)
4	Relay 4	Switching contact 230 VAC / 10 A ($\cos \Phi = 1$)
N	Mains power neutral	Mains power input (refer to chapter 7.1.1).
⊕	Mains power earth	
L	Mains power phase	

B Default Configuration

From the factory, the ETC is supplied in the default configuration. These settings can be reloaded (see chapter 17.6).

Parameter	Value	Chapter	Page
Time + Date		9	21
Time zone	02	9.2	21
Quartz correction	0.00 s	9.3	21
Time correction	0.00 s	9.4	21
Timecode output	Off	9.5	22
Synchronisation		10	23
Time source	none	10.1	23
Interface	RS 232	10.2	23
Time zone	00 / 01 (MSF) / 02 (DCF)	10.5	24
Synchronisation only	No	10.6	24
Alarm timeout	1440 min	10.7	25
Baudrate mode	Auto	10.3	24
Baudrate	19200	10.4	24
System address	01	10.8	25
IP address	0.0.0.0	10.10	25
Subnet mask	0.0.0.0	10.11	25
Gateway	0.0.0.0	10.12	25
Source 1	0.0.0.0	10.13	26
Source 2	0.0.0.0	10.13	26
DHCP	Off	10.14	26
State / Alarms		11	27
Mask alarm relay / display	Without masking	11.2.4	29
Mask CAS, ETC 24(R)	Without masking	11.2.4	29
Slave Clock Lines		12	31
Line type ETC 14(R) / 24(R)	MOBALine	12.1	31
Line type ETC 12(R)	Impulse	12.1	31
Line state	stop	12.4.1, 12.5.1, 12.7.2	34, 37, 42
Time zone	00	12.4.5, 12.5.3, 12.7.5	35, 37, 43
World time zones [01...20]	00	12.7.7	43
Current supervision/allocation ETC 24(R) :			
High limit (lines 1+2)	1000	12.3	33
Low limit (lines 1+2)	0000	12.3	33
Line 1 [%]	050	12.3	33
Line 2 [%]	050	12.3	33
Impulse Line			
Line mode	sec	12.4.4	35
Pulse length	0.2	12.4.6	36
Pulse Pause	0.3	12.4.6	36
Period	12 h	12.4.7	36
DCF Output			

DCF-Impulse default	01	12.5.4	38
MOBALine			
Line mode	10 sec	12.7.4	42
Switch program	ON	12.7.6	43
World time	OFF	12.7.6	43
World time zone [01...20]	00	12.7.7	43
Serial Communication		13	44
Port COM 1 [RS232], Port COM2 [RS422]			
Mode	Off	13.2.2	46
Time zone	00	13.2.3	47
Baudrate	9600	13.2.4	48
Parity	even	13.2.4	48
Databits	7	13.2.4	48
Stopbits	1	13.2.4	48
Telegram	IF482	13.2.5	48
Send offset	0000	13.2.6	48
Relays		14	50
Relays 1...4	Channel 1...4	14.2	50
Switch program / Device Supervision		15 / 16	51 / 59
Control inputs ETC 24(R)			
Combination	AND	15.6	57
Function	Prog.	16	59
Channel	00	15.6	57
Al. timeout [s]	02	16	59
File manager		16	59
Remote download	No	17.8	63
Miscellaneous		18	64
Language	German	18.1	64
Contrast	50	18.2.1	64
Backlight	Auto	18.2.2	64

C Time Zone Table

D Entrées de fuseaux horaires du tableau de saison standard (version 10.0).

Time zone	City / State	UTC Offset	DST Change	Standard → DST	DST → Standard
00	UTC (GMT), Monrovia, Casablanca	0	No		
01	London, Dublin, Edinburgh, Lisbon	0	Yes	Last Sun. Mar. (01:00)	Last Sun. Oct. (02:00)
02	Brussels, Amsterdam, Berlin, Bern, Copenhagen, Madrid, Oslo, Paris, Rome, Stockholm, Vienna, Belgrade, Bratislava, Budapest, Liubliana, Prague, Sarajevo, Warsaw, Zagreb	+1	Yes	Last Sun. Mar. (02:00)	Last Sun. Oct. (03:00)
03	Athens, Istanbul, Helsinki, Riga, Tallinn, Sofia, Vilnius	+2	Yes	Last Sun. Mar. (03:00)	Last Sun. Oct. (04:00)
04	Bucharest, Romania	+2	Yes	Last Sun. Mar. (03:00)	Last Sun. Oct. (04:00)
05	Cairo, Pretoria, Harare	+2	No		
06	Amman	+2	Yes	Last Thu. Mar. (23:59)	Last Fri. Oct. (01:00)
07	UTC (GMT)	0	No		
08	Kuwait City, Minsk, Kaliningrad	+3	No		
09	Praia, Cape Verde	-1	No		
10	UTC (GMT)	0	No		
11	Abu Dhabi, Muscat, Tbilisi, Moscow, St. Petersburg, Volgograd, Samara	+4	No		
12	Kabul	+4.5	No		
13	Adamstown (Pitcairn Is.)	-8	No		
14	Tashkent, Islamabad, Karachi	+5	No		
15	Mumbai, Calcutta, Madras, New Delhi, Colombo	+5.5	No		
16	Astana, Thimphu, Dhaka, Yekaterinburg	+6	No		
17	Bangkok, Hanoi, Jakarta, Novosibirsk	+7	No		
18	Beijing, Chongqing, Hong kong, Singapore, Taipei, Urumqi, Krasnoyarsk	+8	No		
19	Tokyo, Osaka, Sapporo, Seoul, Irkutsk	+9	No		
20	Gambier Island	-9	No		
21	South Australia: Adelaide	+9.5	Yes	1 st Sun. Oct (02:00)	1 st Sun. Apr. (03:00)
22	Northern Territory: Darwin	+9.5	No		
23	Brisbane, Guam, Port Moresby, Yakutsk	+10	No		
24	Sydney, Canberra, Melbourne, Tasmania: Hobart	+10	Yes	1 st Sun. Oct. (02:00)	1 st Sun. Apr. (03:00)
25	UTC (GMT)	0	No		
26	UTC (GMT)	0	No		

27	Honiara (Solomon Is.), Noumea (New Caledonia), Vladivostok	+11	No		
28	Auckland, Wellington	+12	Yes	Last Sun. Sep. (02:00)	1 st Sun. Apr. (03:00)
29	Majuro (Marshall Is.), Magadan, Anadyr	+12	No		
30	Azores	-1	Yes	Last Sun. Mar. (00:00)	Last Sun. Oct. (01:00)
31	Middle Atlantic	-2	No		
32	Brasilia	-3	Yes	3 rd Sun. Oct. (00:00)	3 rd Sun. Feb. (00:00)
33	Buenos Aires	-3	No		
34	Newfoundland, Labrador	-3.5	Yes	2 nd Sun. Mar. (02:00)	1 st Sun. Nov. (02:00)
35	Atlantic Time (Canada)	-4	Yes	2 nd Sun. Mar. (02:00)	1 st Sun. Nov. (02:00)
36	La Paz	-4	No		
37	Bogota, Lima, Quito	-5	No		
38	New York, Eastern Time (US & Canada)	-5	Yes	2 nd Sun. Mar. (02:00)	1 st Sun. Nov. (02:00)
39	Chicago, Central Time (US & Canada)	-6	Yes	2 nd Sun. Mar. (02:00)	1 st Sun. Nov. (02:00)
40	Tegucigalpa, Honduras	-6	No		
41	Phoenix, Arizona	-7	No		
42	Denver, Mountain Time	-7	Yes	2 nd Sun. Mar. (02:00)	1 st Sun. Nov. (02:00)
43	Los Angeles, Pacific Time	-8	Yes	2 nd Sun. Mar. (02:00)	1 st Sun. Nov. (02:00)
44	Anchorage, Alaska (US)	-9	Yes	2 nd Sun. Mar. (02:00)	1 st Sun. Nov. (02:00)
45	Honolulu, Hawaii (US)	-10	No		
46	Midway Islands (US)	-11	No		
47	Mexico City, Mexico	-6	Yes	1 st Sun. Apr. (02:00)	Last Sun. Oct. (02:00)
48	Adak (Aleutian Is.)	-10	Yes	2 nd Sun. Mar. (02:00)	1 st Sun. Nov. (02:00)
49	UTC (GMT)	0	No		
50	UTC (GMT)	0	No		
51	UTC (GMT)	0	No		
52	UTC (GMT)	0	No		
53	UTC (GMT)	0	No		
54	Scoresbysund, Greenland	-1	Yes	Last Sun. Mar. (00:00)	Last Sun. Oct. (01:00)
55	Nuuk, Greenland	-3	Yes	Last Sat. Mar. (22:00)	Last Sat. Oct. (23:00)
56	Qaanaaq, Greenland	-4	Yes	2 nd Sun. Mar. (02:00)	1 st Sun. Nov. (02:00)
57	Western Australia: Perth	+8	No		
58	Caracas	-4.5	No		
59	CET standard time	+1	No		
60	Santiago, Chile	-4	Yes	2 nd Sun. Oct. (00:00)	2 nd Sun. Mar. (00:00)
61	Chile, Easter Island	-6	Yes	2 nd Sat. Oct. (22:00)	2 nd Sat. Mar. (22:00)
62	Baku	+4	Yes	Last Sun. Mar. (04:00)	Last Sun. Oct. (05:00)
63	UTC (GMT)	0	No		
64	UTC (GMT)	0	No		

In countries where the DST switch date changes annually (e.g. Iran, Israel), the time zone has to be defined manually in the user time zone table (entries 80 – 99).

Legend:

UTC: Universal Time Coordinate, equivalent to GMT
DST: Daylight Saving Time
DST Change: Daylight Saving Time changeover
Standard → DST: Time change from Standard time (Winter time) to Summer time
DST → Standard: Time change from Summer time to Standard time (Winter time)

Example:

2nd last Sun. Mar. (02:00) Switch over on the penultimate Sunday in March at 02.00 hours local time.



Attention:

As usual, the time table is adapted each year. You can download the newest time table from our homepage: www.mobatime.com → Customer Area → Customer Support → Support Resources → Software Tools → Time Zone Table. If the delivered device contains a newer version as showed in this manual, it's recommended to check the time zone entries.

E D Alarm List

The ETC is able to generate up to 16 different alarms depending on the device type. Those alarms are identified by the letters A to P.

A	Failure of external time reception: Within the configured alarm timeout (Chapter 10.7), no valid time package was received from the external time source.
B	Internal hardware error
C	Checksum of the saved configuration data is incorrect
D	Error in the automatic quartz trimming: External time source is imprecise or internal quartz is faulty. Error is automatically reset as soon as the deviation from the external time source to the internal quartz sinks again below 50 ppm.
E	Mains power failure
F	Automatic shut down of slave clock line 1 due to overload or short circuit
G	Automatic shut down of slave clock line 2 due to overload or short circuit
H	High current limit exceeded on slave clock line 1
I	High current limit exceeded on slave clock line 2
J	Low current limit under-run on slave clock line 1
K	Low current limit under-run on slave clock line 2
L	Battery voltage low
M	Supervision alarm external device, control input 1
N	Supervision alarm external device, control input 2
O	Supervision alarm external device, control input 3
P	Reserved

F Definitions of Protocols

E.2 NMEA 0183 – Protocol

The following parameters apply for synchronisation from GPS with the NMEA protocol (setting GPS-NMEA, Chapter 10.1):

Protocol:	NMEA 0183 from Version 2.0 or higher
Interface :	RS422
Communication parameters:	4800 Baud, 8 data bits, 1 stop bit, no parity
Synchronisation:	1 PPS signal (current loop)
Expected NMEA packets:	GGA (reception quality) ZDA (UTC time and date)

Important:

The specified NMEA packets must be:

- a) sent automatically by the GPS receiver at periodic intervals (at least every 10 s),
- or
- b) requested by the ETC by means of a query telegram (\$xxGPQ,ZDA*FF and \$xxGPQ,GGA*FF).

The used receiver may need to be reconfigured.

E.3 IF482 – Telegram

For synchronisation via the serial MB IF482 telegram (setting IF482, Chapter 10.1) the following parameters apply:

Protocol: MB IF482 telegram; format see below
 Interface : RS232 or RS422
 Communication parameters: 9600 Baud, 7 data bits, 1 stop bit, even parity
 Synchronisation: Telegram ends at the beginning of the second specified in the telegram
 Cycle: 1 second

Format IF482:

Byte:	Meaning:	Character:	HEX Code:
1	Start character	O	4F
2	Status A: System synchronized M: System not synchronized / loss of time > 12 h	A / M	41 / 4D
3	Season U: UTC W: Winter (standard time) S: Summer (daylight saving time)	U / W / S	55 / 57 / 53
4	Year tens	0..9	30..39
5	Year units	0..9	30..39
6	Month tens	0 / 1	30 / 31
7	Month units	0..9	30..39
8	Day tens	0..3	30..33
9	Day units	0..9	30..39
10	Weekday (Mo..Su)	1..7	31..37
11	Hours tens	0..2	30..32
12	Hours units	0..9	30..39
13	Minutes tens	0..5	30..35
14	Minutes units	0..9	30..39
15	Seconds tens	0..5	30..35
16	Seconds units	0..9	30..39
17	Telegram end character	<CR>	0D

E.4 DIEM – Telegram

Byte:	Meaning:	Character:	HEX Code:
1	Start character	T	54
2	Separator	:	3A
3	Year tens	0..9	30..39
4	Year units	0..9	30..39
5	Separator	:	3A
6	Month tens	0 / 1	30 / 31
7	Month units	0..9	30..39
8	Separator	:	3A
9	Day tens	0..3	30..33
10	Day units	0..9	30..39
11	Separator	:	3A
12	Weekday tens	0	30
13	Weekday units (Mo..Su)	1..7	31..37
14	Separator	:	3A
15	Hours tens	0..2	30..32
16	Hours units	0..9	30..39
17	Separator	:	3A
18	Minutes tens	0..5	30..35
19	Minutes units	0..9	30..39
20	Separator	:	3A
21	Seconds tens	0..5	30..35
22	Seconds units	0..9	30..39
23	Telegram end character 1	<CR>	0D
24	Telegram end character 2	<LF>	0A

E.5 SINEC – Telegram

Byte:	Meaning:	Character:	HEX Code:
1	Start character	<STX>	02
2	Date identifier	D	44
3	Separator 1	:	3A
4	Day tens	0..3	30..33
5	Day units	0..9	30..39
6	Separator 2	.	2E
7	Month tens	0 / 1	30 / 31
8	Month units	0..9	30..39
9	Separator 2	.	2E
10	Year tens	0..9	30..39
11	Year units	0..9	30..39
12	Separator 3	;	3B
13	Weekday identifier	T	54
14	Separator 1	:	3A
15	Weekday (Mo..Su)	1..7	31..37
16	Separator 3	;	3B
17	Time identifier	U	55
18	Separator 1	:	3A
19	Hours tens	0..2	30..32
20	Hours units	0..9	30..39
21	Separator 2	.	2E
22	Minutes tens	0..5	30..35
23	Minutes units	0..9	30..39
24	Separator 2	.	2E
25	Seconds tens	0..5	30..35
26	Seconds units	0..9	30..39
27	Separator 3	;	3B
28	Status 1 #: No synchronization since last reset	<SP> / #	20 / 23
29	Status 2 *: Free running based on internal quartz	<SP> / *	20 / 2A
30	Status 3 S: Summer (daylight saving time, season time) U: UTC time	<SP> / S / U ¹⁾	20 / 53 / 55 ¹⁾
31	Status 4 !: Season change announcement during 1 h	<SP> / !	20 / 21
32	Telegram end character	<ETX>	03

 ¹⁾ If the output of the character 'U' for UTC time should be suppressed, a user specific time zone table with the corresponding entry 00 should be loaded to the ETC (Appendix C and Chapter 17.5). Instead of the entry 00, the user defined entry (position 80 or higher) shall be selected in the menu of the serial interface.

E.6 H7001 – Telegram

Byte:	Meaning:	Character:	HEX Code:
1	Start character	<STX>	02
2	Status (Low nibble, binary → ASCII) Bit 0=1: Season change announcement Bit 1=1: Summer (daylight saving time) Bit 2=1, Bit 3=0: Quartz operation Bit 2=1, Bit 3=1: Radio operation	0..15	30..39, 41..46
3	Weekend (Low nibble, binary → ASCII) Bit 0=1: Telegram content UTC Bit 1=1: Weekday binary weight 1 (Sum 1..7 = Mo..Su) Bit 2=1: Weekday binary weight 2 Bit 3=1: Weekday binary weight 4	0..15	30..39, 41..46
4	Hours tens	0..2	30..32
5	Hours units	0..9	30..39
6	Minutes tens	0..5	30..35
7	Minutes units	0..9	30..39
8	Seconds tens	0..5	30..35
9	Seconds units	0..9	30..39
10	Day tens	0..3	30..33
11	Day units	0..9	30..39
12	Month tens	0 / 1	30 / 31
13	Month units	0..9	30..39
14	Year tens	0..9	30..39
15	Year units	0..9	30..39
16	Telegram end character 1	<LF>	0A
17	Telegram end character 2	<CR>	0D
18	Telegram end character 3	<ETX>	03

E.7 BUS485 – Telegram

The format BUS485 is used for the synchronization of devices over RS 485 and is therefore only available on ETC's RS422 interface. The telegrams are addressed as broadcast (destination address h'00FF). For this message the number of the data bits has to be set to "8 Bits", because the telegram content is not ASCII but hexadecimal coded.

Byte:	Meaning:	Character:	HEX Code:
1	Start character (High Byte)		FE
2	Start character (Low Byte)		01
3	Length of data packet (High Byte)		0E
4	Length of data packet (Low Byte)		00
5	Command (High Byte)		00
6	Command (Low Byte)		01
7	Destination address (High Byte)		00
8	Destination address (Low Byte)		FF
9	Source address (High Byte)		00
10	Source address (Low Byte)		7F
11	Compact time byte 1 (Seconds since 1.1.1993)		00..FF
12	Compact time byte 2 (Seconds since 1.1.1993)		00..FF
13	Compact time byte 3 (Seconds since 1.1.1993)		00..FF
14	Compact time byte 4 (Seconds since 1.1.1993)		00..FF
15	Compact time byte 5 (Milliseconds High Byte)		00
16	Compact time byte 6 (Milliseconds Low Byte)		00
17	CRC16 check sum (High Byte)		00..FF
18	CRC16 check sum (Low Byte)		00..FF
19	Telegram end character (High Byte)		FE
20	Telegram end character (Low Byte)		02

G Connection of GNSS 3000 and GPS / GNSS 4500 Satellite Receiver

Connection diagram ETC with GPS / GNSS 4500 or GNSS 3000 Satellite Time Signal Receiver

ETC 12 / 14 / 24

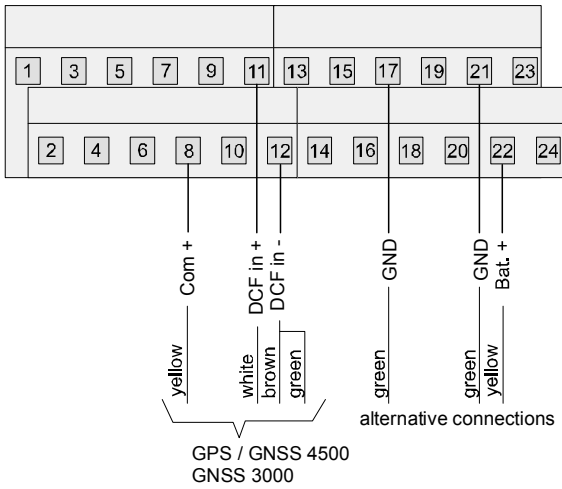

ETC 24R

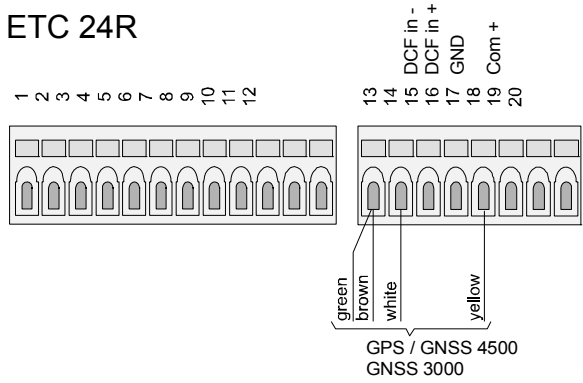

ETC 12R /14R

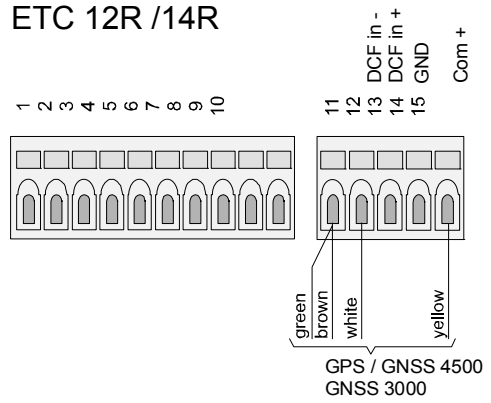

H Technical Data

EMC	EN 61000-6-2 / EN 61000-6-4 / EN 50121-4
Safety	EN 62368-1 / Protection class I
Dimensions	19" rack, 2HE (H x W x D [mm] = 483 x 88 x 80) Plastic case, (H x W x D [mm] = 200 x 145 x 64), see drawing below
Weight	approx. 2 kg
Ambient temperature	0 to 50°C, 10-90% relative humidity, without condensation
Microprocessor	16 Bit, RAM buffered, real-time clock (RTC), flash memory
Lithium battery	Type: CR 2032 3V / 0.23 Ah Storage shelf life: 2 years Operational service life: 15 years
Display	4 x 20 characters with backlighting
Menu languages	German, English, French, Russian, Portuguese and Danish selectable
Keypad	Alphanumeric with navigation keys
Accuracy	Time output (synchronized): +/- 10 ms absolute Autonomous operation (standard quartz): +/- 0.1 s per day (observed for 24 h), at 20°C +/- 5°C.
Switch program	99 week programs, 64 channel programs, total 1000 program lines, 3 control inputs for twilight switch and similar devices.
Time zones	80 predefined, 20 on PC freely programmable entries
Time sources	DCF, MSF, GPS 4500, GPS-TSIP, GPS-NMEA (RS422: packets GGA and ZDA min. every 10 s or on request, query), IF482 telegram (RS232 / RS422 selectable), minute pulses, CAS, CAN or none (autonomous).
Synchronization inputs	Active current loop input for two wire DCF / MSF time signal receiver, 2 interfaces (RS232 / RS422) for time synchronization from GPS (only RS422), periodic serial ASCII time telegram (definition MB, IF482) or CAS protocol, input for synchronization pulse 1PPS from GPS (DCF current loop input).
DCF output	Synthetic (software generated) DCF time code with selectable time zone on passive current loop. Optocoupler: $U_{max} = 30$ VDC, $I_{on} = 10..15$ mA, $I_{off} = 2$ mA @ 20 VDC
Alarm contact	Opening relay contact (alarm active → contact open). Switching load: 30 W (60 VDC or 1A) or 60 VA (30 VAC or 1A)
DC power supply	Nominal voltage 24 VDC +20% / -10%, Max. 1.5 A
DC Output	DC voltage output 22..29 VDC 200 mA max.
Power consumption	ETC 14/24: max. 30 W ETC 12: max. 12 W
Mains Power Supply	ETC 14/24: 90 – 240 VAC, 50/60 Hz, 0.4 A / max. 30 VA ETC 12: 230 VAC +/- 10%, 50/60 Hz, 60 mA / max. 12 VA

Dimensions of ETC 12 / 14 / 24:

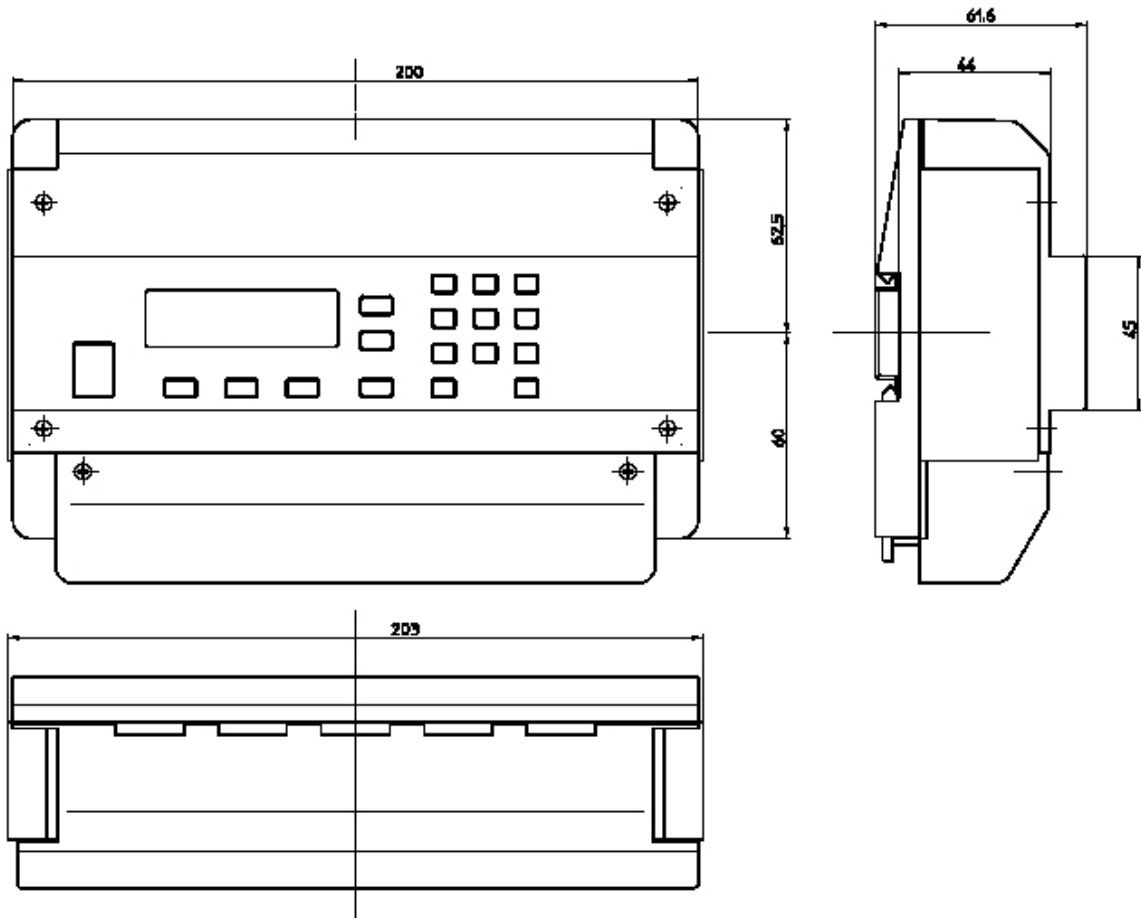

Lithium battery exchange:

The Lithium battery is used for the real time clock, to keep the time, when ETC power is down. The configuration of the ETC is stored in a non-volatile memory. So no risk, to lose configuration, when Lithium battery is down.

The battery can be easily changed. It is on a socket. Type of battery: CR2032.

You have to remove the front cover with 4 screws, then remove the core board with 2 screws (pos. 23) (PCB with display, pos. 3) and you will reach the battery on the back side of this PCB (pos. 7).

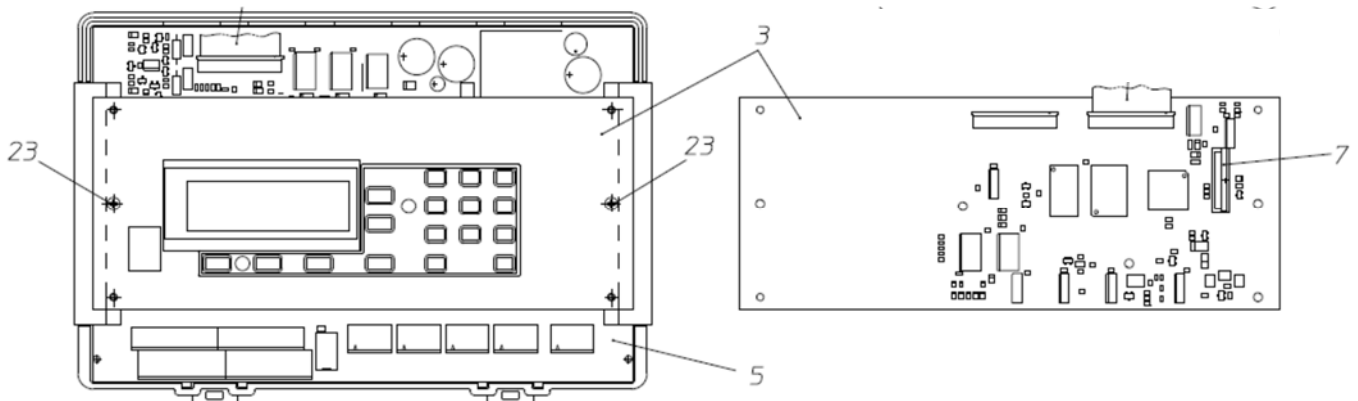

I Index

A

Accuracy	89
Alarm	28
Alarm contact	30, 73, 76
Alarm display	29
Alarm list	28, 81
Alarm masking	29
Alarm reset	29
Alarm timeout	25, 81
Alarms stored	29

B

Battery - total discharge	18
Battery exchange	91
Baudrate	24, 48

C

CAN - communication	47
CAN - M/S network interface	25
CAN - network parameter	25
CAN - state	25
CAS protocol	23, 24, 25
Channel monitor	51, 56
Channel program	51, 54
Channel relay	43, 52
Communication Parameters	48
Communication Parameters - standard	47
Configuration data	60
Connection - DCF	69
Connection Diagrams	68
Control input	51, 57, 73, 76

D

Databits	48
Date set	21
Daylight Saving Time	80
DC power supply	17
DCF	19, 22, 23, 89
DCF mode	38
DCF Output	37
DCF-Impulse-Output	39
DCF-Impulse-Output - Line Mode	41
Default configuration	60, 62, 77
Dimensions	89, 91
Display backlight	64
Display contrast	64
Download	60
Download - remote	63
Download - season table	62
Download - switch program	61
Download - system software	61
DST	80

E

Earth – power earth	16
Errors during download	60
ETCW software	52
ETCW-Software	60

F

Factory settings	62, 77
Flash memory	60, 61, 62

G

GNSS 4500	88
GPS	23, 82
GPS 4500	19, 88

H

Hardware version	64
------------------	----

I

IF 482 telegram	23, 83
Impulse length	36
Impulse Line - catch-up periodicity	36
Impulse Line - line mode	35
Impulse Line - line time & date	34
Impulse pause	36

K

Keypad lock	14
-------------	----

L

Language	64, 89
Line current allocation	33
Line current supervision	32
Lithium battery	17, 89
Lithium battery exchange	91

M

Mains power supply	16
Maintenance	66
Minute impulse	19, 23
MOBALine	42
MOBALine - switch program	43
MOBALine - world time function	43
modify-key	14
MSF	19, 23

N

NMEA 0183 protocol	23, 82
--------------------	--------

P

Parity	48
Power consumption	89
Power supply - mains / batt.	65

Q			
Quartz correction	21		
Quartz drift	21		
Quartz trimming	28, 81		
R			
RAM	60		
Reception quality	27		
Relay	50		
Reset with Hotkey-Combination	67		
RS 232 interface	63		
RS 485	44		
RTC (Real Time Clock)	13, 17		
Running reserve	17		
S			
Season table	79		
Self-setting slave clock	42		
Serial interface	23, 83		
Serial interface - download	60		
Serial interface - line time & date	46		
Serial interface - Overview	44		
Serial time telegram	20		
Signal	51		
Signal quality	27		
Slave clock lines	31		
Software version	64		
Start-up	12		
Stopbits	48		
Supervision of external devices	59		
Switch program	51		
Switch program - delete	61		
Switch program - download	61		
Switch program - read (upload)	62		
Switch program - relay channel assignment	50		
		Switch program - relay switching states	50
		SwitchEditor	52, 61
		Synchronization	23
		Synchronization only	24
		Synthetic DCF	22, 69
		System address	25
		T	
		Telegram definitions	83
		Telegram Format	48
		Telegram quality	27
		Telegram Send Offset	48
		Telegram send period	49
		Time Administration	13
		Time correction	21
		Time set	21
		Time signal receiver	19
		Time source	19, 23
		Time zone	13, 79
		Time zone - DCF output	37
		Time zone - DCF-impulse output	41
		Time zone - Impulse Line	35
		Time zone - master clock time	21
		Time zone - MOBALine	43
		Time zone - serial interface	47
		Time zone - time source	24
		Time zone table	79
		Troubleshooting	66
		U	
		User configuration	62
		UTC	13, 80
		W	
		Week program	51

HEADQUARTERS / PRODUCTION

MOSER-BAER AG
Spitalstrasse 7, CH-3454 Sumiswald
Tel. +41 34 432 46 46 / Fax +41 34 432 46 99
moserbaer@mobatime.com / www.mobatime.com

SALES WORLDWIDE

MOSER-BAER SA EXPORT DIVISION
19 ch. du Champ-des-Filles, CH-1228 Plan-les-Ouates
Tel. +41 22 884 96 11 / Fax + 41 22 884 96 90
export@mobatime.com / www.mobatime.com

SALES SWITZERLAND

MOBATIME AG
Stettbachstrasse 5, CH-8600 Dübendorf
Tel. +41 44 802 75 75 / Fax +41 44 802 75 65
info-d@mobatime.ch / www.mobatime.ch

MOBATIME SA
En Budron H 20, CH-1052 Le Mont-sur-Lausanne
Tél. +41 21 654 33 50 / Fax +41 21 654 33 69
info-f@mobatime.ch / www.mobatime.ch

SALES GERMANY, AUSTRIA

BÜRK MOBATIME GmbH
Postfach 3760, D-78026 VS-Schwenningen
Steinkirchring 46, D-78056 VS-Schwenningen
Tel. +49 7720 8535 0 / Fax +49 7720 8535 11
buerk@buerk-mobatime.de / www.buerk-mobatime.de

