

# MOUNTING AND INSTRUCTION MANUAL

## TREND MOBALine

MOBALine analog clock



# Table of contents

---

1	Safety .....	3
1.1	Safety instructions .....	3
1.2	Symbols and Signal Words used in this Instruction Manual .....	3
1.3	Observe operating safety! .....	3
1.4	Consider the installation site! .....	3
1.5	Please observe the electromagnetic compatibility! .....	3
2	Maintenance .....	4
2.1	Troubleshooting: Repairs .....	4
2.2	Cleaning .....	4
2.3	Disposing .....	4
3	General Information: Introduction .....	5
3.1	Measurements .....	5
3.2	Introduction .....	5
3.3	Power supply .....	5
3.4	Accuracy / Synchronization breakdown .....	5
4	Mounting guidelines .....	6
4.1	Connections .....	6
4.2	Mounting single-sided clock .....	6
4.3	Mounting double-sided clock .....	6
5	Configuration .....	7
6	Startup, configuration and monitoring with NMI .....	8
6.1	Startup .....	8
6.2	Monitoring configuration .....	8
6.3	Monitoring .....	9
7	Accessories .....	10
8	Technical data .....	10

## Certification of the Producer

### STANDARDS

The MOBALine clock TREND was developed and produced in accordance with the EU Guidelines  
2006 / 95 / EC  
2004 / 108 / EC  
96 / 48 / EC



## References to the Instruction Manual

1. The information in this Instruction Manual can be changed at any time without notice.  
The current version is available for download on [www.mobatime.com](http://www.mobatime.com).
2. This Instruction Manual has been composed with the utmost care, in order to explain all details in respect of the operation of the product. Should you, nevertheless, have questions or discover errors in this Manual, please contact us.
3. We do not answer for direct or indirect damages, which could occur, when using this Manual.
4. Please read the instructions carefully and only start setting-up the product, after you have correctly understood all the information for the installation and operation.
5. The installation must only be carried out by skilled staff.
6. It is prohibited to reproduce, to store in a computer system or to transfer this publication in a way or another, even part of it. The copyright remains with all the rights with BÜRK MOBATIME GmbH, D-78026 VS-Schwenningen and MOSER-BAER AG – CH 3454 Sumiswald / SWITZERLAND.



### Installation and Handling Notice

This clock may only be transported in its original packaging and must be kept dry.

# 1 Safety

---

## 1.1 Safety instructions

---

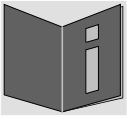



Read this chapter and the entire instruction manual carefully and follow all instructions listed. This is your assurance for dependable operations and a long life of the device.

Keep this instruction manual in a safe place to have it handy every time you need it.

## 1.2 Symbols and Signal Words used in this Instruction Manual

---

	<b>Danger!</b> Please observe this safety message to avoid electrical shock! There is danger to life!
	<b>Caution!</b> Please observe this safety message to avoid damages to property and devices!

## 1.3 Observe operating safety!

---



**Caution!**

- Never open the housing of the device! This could cause an electric short or even a fire, which would damage your device. Do not modify your device!
- The device is not intended for use by persons (including children) with limited physical, sensory, or mental capacities or a lack of experience and/or knowledge.
- Keep packaging such as plastic films away from children. There is the risk of suffocation if misused.

## 1.4 Consider the installation site!

---



**Caution!**

- To avoid any operating problems, keep the device away from moisture and avoid dust, heat, and direct sunlight. Do not use the device outdoors.



### **Danger! Make sure**

that you wait before using the device after any transport until the device has reached the ambient air temperature. Great fluctuations in temperature or humidity may lead to moisture within the device caused by condensation, which can cause a short.

## 1.5 Please observe the electromagnetic compatibility!

---



**Caution!**

- This device complies with the requirements of the EMC and the Low-voltage Directive.

## 2 Maintenance

---

### 2.1 Troubleshooting: Repairs

---

If you cannot rectify the problems, contact your supplier from whom you have purchased the device.

Any repairs must be carried out at the manufacturer's plant.

Disconnect the power supply immediately and contact your supplier, if ...

- liquid has entered your device
- the device does not properly work and you cannot rectify this problem yourself.

### 2.2 Cleaning

---

- Please make sure that the device remains clean especially in the area of the connections, the control elements, and the display elements.
- Clean your device with a damp cloth only.
- Do not use solvents, caustic, or gaseous cleaning substances.

### 2.3 Disposing

---



#### Device

At the end of its lifecycle, do not dispose of your device in the regular household rubbish. Return your device to your supplier who will dispose of it correctly.



#### Packaging

Your device is packaged to protect it from damages during transport.

Packaging is made of materials that can be disposed of in an environmentally friendly manner and properly recycled.

## 3 General Information: Introduction

---

### 3.1 Measurements

---

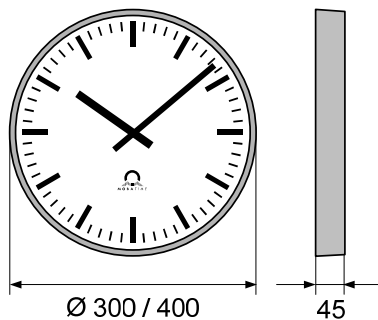

All specifications in mm.

### 3.2 Introduction

---

The **TREND** is a self-setting clock with hour, minute and second hand. It is powered and synchronized by the MOBALine signal. It is available in the diameters 30 cm and 40 cm.

Features:

- MOBALine controlled by connected MOBALine master clock with automatic time takeover and daylight saving time change.
- Signalization of a missing MOBALine time signal after 24 hours by setting the hands to the 12 o'clock position.
- Two motors for hour / minute hand and second hand.
- Push-button for the configuration for operation with the NMI interface.
- The operating mode of the minute hand is controlled by the MOBALine signal (identical for all clocks of a clock line).
- Powered by MOBALine.

### 3.3 Power supply

---

The clock is powered by the MOBALine slave clock line.

Power consumption from MOBALine: max. 10 mA

### 3.4 Accuracy / Synchronization breakdown

---

The deviation in the synchronized state is typically smaller than +/-50 ms.

The clock signals a synchronization breakdown after 24 hours by setting the hands to the 12 o'clock position. The deviation after 24 h without synchronization is typically smaller than +/-2 s (quartz accuracy: 20 ppm at room temperature).

**Notice:** the mentioned deviations depend on the accuracy and the capacity of the master clock (MOBALine).

## 4 Mounting guidelines

### 4.1 Connections

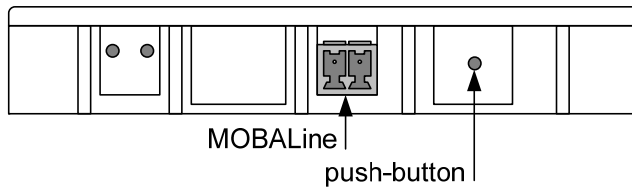

### 4.2 Mounting single-sided clock

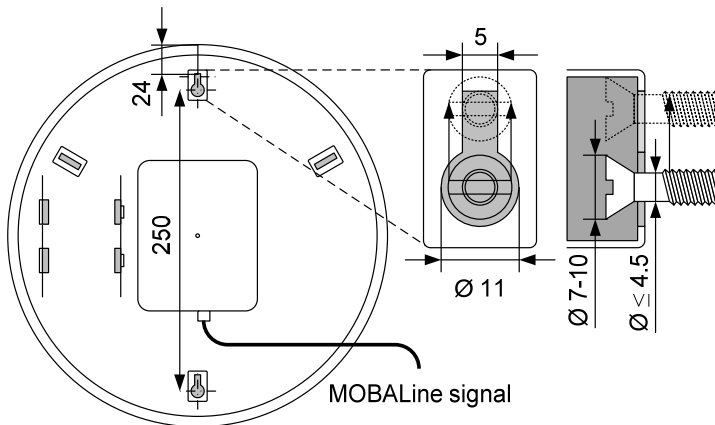

### 4.3 Mounting double-sided clock

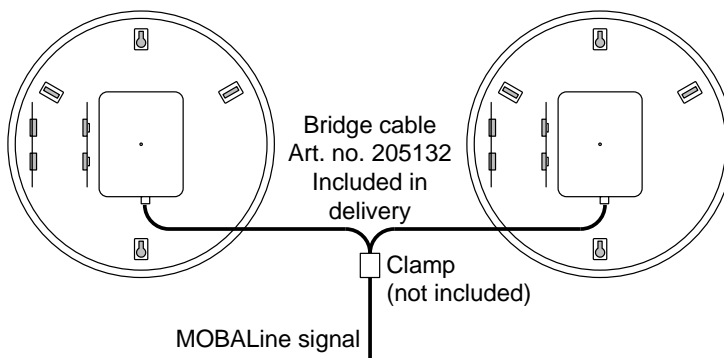
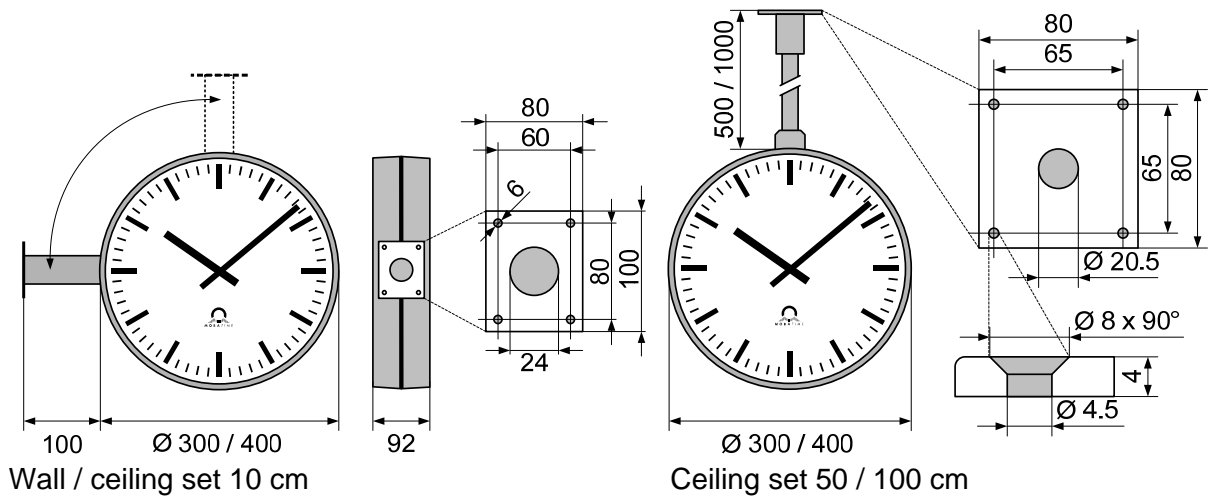

## 5 Configuration

---

The TREND clock features a push-button on the rear (see chapter **Fehler! Verweisquelle konnte nicht gefunden werden. Fehler! Verweisquelle konnte nicht gefunden werden.**). It can be pushed using a pointy object (e.g. a paper clip).

The following settings can be modified using the push-button:

- Configuration of a clock ID for surveillance using an NMI
- Set clock hands to 12 o'clock position

### **Set clock to 12 o'clock position**

1. Hold push-button for 5 seconds. Clock changes to 12 o'clock mode.
2. Press push-button once, clock changes back to normal mode.

### **Configuration and surveillance with an NMI**

See chapter 6.

## 6 Startup, configuration and monitoring with NMI

---

TREND clocks can be monitored using an NMI. For configuring and monitoring clocks using NMI, the PC software MOBA-NMS is needed.

### 6.1 Startup

---

1. Connect NMI to Ethernet (Power over Ethernet required)
2. Wire up the TREND clocks and connect them to MOBALine
3. Start up NMI using MOBA-NMS and configure it

Further information about the NMI can be found in the manual BE-800916, information about MOBA-NMS in BE-800793.

### 6.2 Monitoring configuration

---

Using an NMI, up to 12 TREND clocks can be monitored. The clocks to be monitored must be announced to the NMI. This is done using a unique identification number, subsequently called ID. Every monitored clock must possess such an ID.

**Notice:** Each ID may only be used once per NMI. Before the monitoring can take place, the clocks must have received a valid time telegram.

For programming an ID, the following steps are necessary:

1. In MOBA-NMS under Configuration -> NMI Settings -> MOBALine Mode set to ID mode (Clock ID)
2. Clocks show the programmed ID. Clocks without an ID go to the 12 o'clock position. The clocks are delivered without a set ID. The programmed ID is shown using the minute and second hands. Some examples of ID display follow.



3. Using the built-in push-button, the ID can be set in single steps. The push-button's behavior is as follows:

1 short push (< 1 second):	increase ID by 1
2 short pushes (within 1 second):	decrease ID by 1
1 long push (> 1 second):	ID reset (ID to 0)

If the highest ID (12) is reached, the next increase leads to ID 0 (no ID).
4. Every clock to be monitored must be configured using the process described in step 3. In the MOBA-NMS index card „Overview“, after updating the display, the configured clock IDs should change from „not configured“ to „OK“.
5. Once all clocks are assigned IDs, the NMI must be set back to normal operation in the menu Configuration -> NMI Settings -> MOBALine Mode. With this step, all clock IDs will be programmed fix. From this point onward, the NMI can monitor the clocks and the IDs will not be lost e.g. due to a blackout.



## 6.3 Monitoring

Monitoring is limited to a simple „alive message“ (clock connected to MOBALine / clock not connected or defect).

Example correctly monitored clocks:

The screenshot shows the NMI (Network-MBL-IF) monitoring interface. The 'Device Information' section displays the following details:

Status:	OK	Type:	NMI	MAC Address:	00:16:91:01:08:9A
Alarm(s):	--	Location / Desc.:	Network-MBL-IF	Multicast Address:	0.0.0.0
Position:	Normal	Output line mode:	MOBALine	DHCP:	On
Date:	31-Oct-2012	Minute hand mode:	Stepwise	IP Address:	10.241.0.46
Time:	13:54:49	Software:	204880.00.16	Subnet Mask:	255.240.0.0
TZ Source:	Local	Run Mode:	NTP Client Unicast	Gateway:	10.240.2.1
TZ Entry:	0	Config. IP/Port:	10.241.0.46:65532	Last NTP time from:	10.110.3.2

The 'MOBALine clocks status' section shows 12 clocks, all with a green dot and 'OK' status:

Clock ID 1: OK	Clock ID 7: OK
Clock ID 2: OK	Clock ID 8: OK
Clock ID 3: OK	Clock ID 9: OK
Clock ID 4: OK	Clock ID 10: OK
Clock ID 5: OK	Clock ID 11: OK
Clock ID 6: OK	Clock ID 12: OK

At the bottom, there is a 'Refresh' button and a navigation bar with tabs for 'Overview', 'General Settings', 'NMI Settings', and 'Time Zone Settings'.

Example erroneous clocks:

The screenshot shows the NMI (Network-MBL-IF) monitoring interface with an alarm icon in the title bar. The 'Device Information' section displays the following details:

Status:	Alarm	Type:	NMI	MAC Address:	00:16:91:01:08:9A
Alarm(s):	Clock(s) error	Location / Desc.:	Network-MBL-IF	Multicast Address:	0.0.0.0
Position:	Normal	Output line mode:	MOBALine	DHCP:	On
Date:	31-Oct-2012	Minute hand mode:	Stepwise	IP Address:	10.241.0.46
Time:	13:55:37	Software:	204880.00.16	Subnet Mask:	255.240.0.0
TZ Source:	Local	Run Mode:	NTP Client Unicast	Gateway:	10.240.2.1
TZ Entry:	0	Config. IP/Port:	10.241.0.46:65532	Last NTP time from:	10.110.3.2

The 'MOBALine clocks status' section shows 12 clocks, all with a red dot and 'Error' status:

Clock ID 1: Error	Clock ID 7: Error
Clock ID 2: Error	Clock ID 8: Error
Clock ID 3: Error	Clock ID 9: Error
Clock ID 4: Error	Clock ID 10: Error
Clock ID 5: Error	Clock ID 11: Error
Clock ID 6: Error	Clock ID 12: Error

At the bottom, there is a 'Refresh' button and a navigation bar with tabs for 'Overview', 'General Settings', 'NMI Settings', and 'Time Zone Settings'.

Notice:

The clocks are not monitored resp. updated in the 12H mode.

## 7 Accessories

---

- Wall / ceiling set (arm length 10 cm)
- Ceiling set 50 cm
- Ceiling set 100 cm
- Bridge cable 25 cm

## 8 Technical data

---

Synchronization	MOBALine
Regulating time after restart	< 3 minutes 20 seconds daylight saving time change: < 15 seconds
Operating modes	second axis: step operation minute axis: continuous or step operation hour axis: continuous
Operating voltage	MOBALine: > 10 V, 50 Hz
Power consumption	without second hand: < 5 mA @ 17 V with second hand: < 8 mA @ 17 V
Autonomous operation in case of signal loss	24 hours deviation typically <+/-2 s after 24 h
Accuracy (synch.)	better +/- 100 ms
Number of motors	without second hand: 1 (h / min.) with forward and backward motion with second hand: 2 (h / min. + sec.) with forward / backward motion
Temperature area	-10 ... +55 °C
Weight	without second hand: 165 g with second hand: 180 g



### HEADQUARTERS / PRODUCTION

MOSER-BAER AG  
Spitalstrasse 7, CH-3454 Sumiswald  
Tel. +41 34 432 46 46 / Fax +41 34 432 46 99  
moserbaer@mobatime.com / www.mobatime.com

### SALES WORLDWIDE

MOSER-BAER SA EXPORT DIVISION  
19 ch. du Champ-des-Filles, CH-1228 Plan-les-Ouates  
Tel. +41 22 884 96 11 / Fax + 41 22 884 96 90  
export@mobatime.com / www.mobatime.com

### SALES SWITZERLAND

MOBATIME AG  
Stettbachstrasse 5, CH-8600 Dübendorf  
Tel. +41 44 802 75 75 / Fax +41 44 802 75 65  
info-d@mobatime.ch / www.mobatime.ch

MOBATIME SA  
En Budron H 20, CH-1052 Le Mont-sur-Lausanne  
Tél. +41 21 654 33 50 / Fax +41 21 654 33 69  
info-f@mobatime.ch / www.mobatime.ch

### SALES GERMANY, AUSTRIA

BÜRK MOBATIME GmbH  
Postfach 3760, D-78026 VS-Schwenningen  
Steinkirchring 46, D-78056 VS-Schwenningen  
Tel. +49 7720 8535 0 / Fax +49 7720 8535 11  
buerk@buerk-mobatime.de / www.buerk-mobatime.de

